

Sketch-Based Modeling in Mechanical Engineering Design: Current Status and Opportunities

Jorge D. Camba

Purdue University, West Lafayette, IN, USA

jdorribo@purdue.edu

Pedro Company

Universitat Jaume I, Castellón, Spain

pcompany@uji.es

Ferran Naya

Universitat Politecnica de Valencia, Valencia, Spain

fernasan@dig.upv.es

Abstract

Sketch-Based Modeling (SBM) is a field of study that focuses on the automatic creation of 3D models from freehand drawings. Today, two related branches coexist: one aimed at facilitating input for 3D content creation, and the other aimed at routing engineering designs into CAD/CAM/CAE. The latter is the goal of this position paper. Early attempts concentrated on the problem of *line-drawing interpretation*, but efforts switched toward *geometric reconstruction* as the “inverse projection” problem became the most challenging step to produce 3D models from 2D line-drawings. The term SBM was popularized when sketches began to displace line-drawings as main input. In the context of engineering design, interest in SBM has somewhat decreased, as studies have shown that current SBM tools are not as usable as paper and pencil sketches, nor do they yet provide any additional value to traditional media. Furthermore, engineers feel reasonably comfortable with current Mechanical CAD (MCAD) paradigms based on parametric modeling, and fail to recognize the potential benefits of interacting with computers via sketches. However, new technological trends such as personal fabrication and the democratization of CAD and manufacturing can significantly benefit from improved SBM tools. In this paper, we conduct a meta-review of the SBM literature which we view as a combination of three elements: geometry (shape), psychology (perception), and engineering (function). We advocate for a new approach to SBM based on reformulating the weights of these elements as an approach for searching the set of intentions in sketches conveyed through cues which, when perceived, reveal regularities and features of the object. Finally, we consider quality of CAD models not just as error-free models, reusable models, or even models that convey design intent, but models that consider these interrelated aspects as a whole. B-Rep models produced by current SBM approaches are “dumb models” without parameterization or procedures required to enable reusability and ensure that the design intent of the sketch is properly conveyed. We advocate for improved analysis approaches aimed at revealing higher-level design information embedded in engineering sketches, as a critical stage to generate richer 3D MCAD models.

Keywords: Sketch-Based Modeling, Geometric reconstruction, Line-drawing interpretation.

1. Introduction

Sketch-Based Modeling (SBM) studies the automatic creation of 3D models from freehand drawings. The goal is to replicate our innate ability to perceive 3D shapes depicted by 2D drawings using the computer. Some successful SBM tools such as Teddy by Takeo Igarashi et al. [IMT99] have been developed over the years, most of them for artistic purposes. In fact, an active branch of SBM focuses on facilitating input for 3D content creation. The fundamentals are illustrated in the basic example shown in Figure 1. A recent review of the subject was published by Bhattacharjee and Chaudhuri [BC20]. As part of their review, the authors studied the role of Augmented and Virtual Reality technologies as a mechanism for converting the act of sketching into a more powerful yet easy-to-use modality for content creation. Although this particular branch is also applicable and useful for Mechanical CAD models (MCAD) based on free-form shapes [XCS14], the focus of this paper is on analytical shapes for engineering purposes.

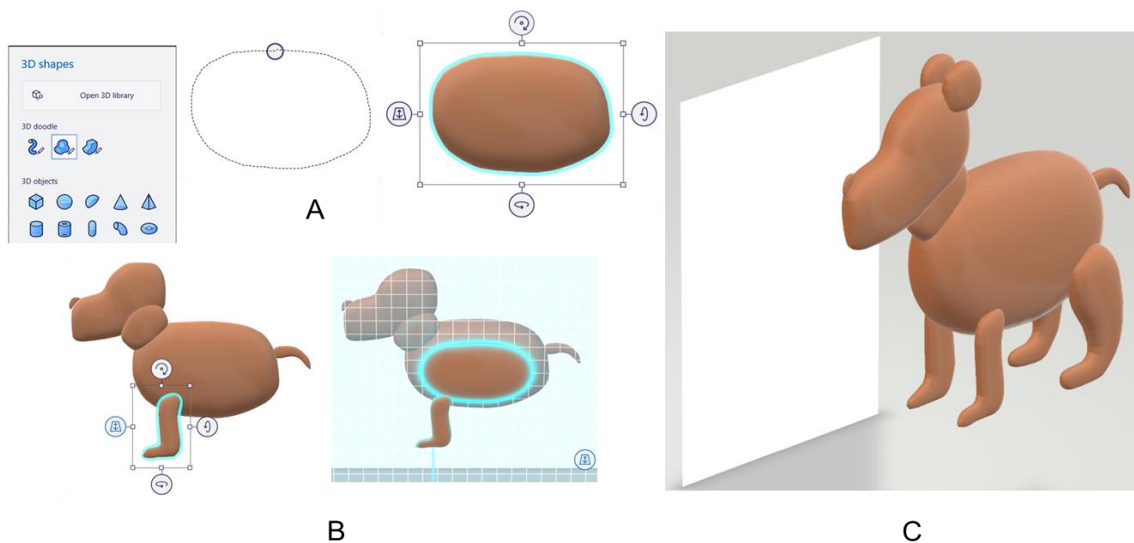

Figure 1. SBM process of a dog using Paint 3D: doodling of a 2D shape that represents the dog’s body. The shape is then used to automatically generate a 3D volume (A); the process is repeated to build the dog’s head and legs. The location of each part of the model can be adjusted by moving the sketch plane (B). The individual parts are then combined into the resulting 3D model (C).

The use of SBM tools in engineering and product design (i.e. in CAD/CAM/CAE environments) has proven extremely challenging. Many efforts have been motivated by the need to facilitate the creation of CAD models with traditional modeling software and to overcome the high learning curve of these systems. Additionally, the vast majority of 3D modeling applications do not leverage the inherent artistic abilities of many users. The goal of SBM is to provide intuitive 3D modeling interfaces that can replicate traditional drawing and sketching instruments.

In this paper, we review the relationship between SBM and engineering design. We highlight the evolution of the terminology and the most significant approaches. From line-drawing interpretation to geometric reconstruction to sketch-based modeling, the focus of SBM research changed from converting legacy blueprints into 3D models to interacting with CAD applications via sketching. Our objective is twofold: summarize the evidence and interpret the findings of the review to advocate for a new SBM paradigm.

Automatically converting input sketches into precise CAD models useful for engineering applications requires several steps, some of which are particularly challenging. In this

paper, we briefly describe these steps and their corresponding state-of-the-art. Finally, we argue that the future of SBM for engineering applications requires perceptually based strategies for improving the detection of cues and for identifying even more sophisticated cues. The process of *inflation* should then be used as an auxiliary approach to detect features, which can finally be combined to produce a procedural feature-based CAD model.

We contend that the evolution of SBM has conditioned the manner in which each research contribution has influenced and interacted with others. The result is that geometric approaches are dominant, psychology is used primarily to complement these geometric approaches, and high-level requirements of designers and engineers are mostly ignored until a final output is produced. In order to make SBM valuable to CAD professionals, we advocate for reformulating the weights of the three types of contributions. Our long-term goal is the development of automated mechanisms that can produce—or at least, facilitate the creation of—*parametric* and *procedural solid* models from hand-drawn engineering sketches. To this end, the reconstruction of models from sketches must come from a new paradigm in SBM based on detecting design features in sketches and using these features to create a model tree that describes a procedural 3D CAD model.

2. Review approach

In this study, we review the use and application of Sketch-Based Modeling (SBM) techniques to the design of engineered products. According to authors Khan et al. [KKK03], a review is systematic if (1) it is based on a clearly formulated question, (2) identifies relevant studies, (3) appraises their quality, (4) summarizes the evidence by use of explicit methodology, and (5) interprets the findings. Some studies develop this five-step approach further. For example, the paper [WBD19] is particularly interesting for two reasons. First, it explains the criteria for searching and accepting (or rejecting) the papers for the review, and second, it compares what is found until the authors can draw their own conclusions. In other words, it is a “meta-analysis.” Although we intend to follow this strategy in our review, quality assessment is not the most critical characteristic when studying SBM, since the available literature is not that extensive so as to force a drastic selection. However, identifying relevant work requires recognizing the fact that the keyword “SBM” is the result of an evolution of *geometric reconstruction* which, in turn resulted from an evolution of *drawing vectorization* and *line-drawing interpretation*. Therefore, we focus on the evolution of the goal, which parallels the evolution of the keywords.

To provide an original and updated assessment of SBM as a field of study, our review is not limited to summarizing the contributions of other authors. Instead, we build a position that contributes to contend a key idea. Our hypothesis is that SBM techniques are largely based on one of two prevailing approaches. In the first approach, the problem of determining the 3D shape depicted by a line drawing or a sketch is considered the inverse problem of geometric projection (the method used to determine the depth information that is lost when a 3D model is projected to produce a flat image is known as *inflation*). In the second approach, the line drawing (or the sketch) is viewed as information encoded in a well-defined language (i.e., the graphical language). Therefore, the tasks of *perceiving* and *reading* this information—according to the rules of visual perception and the rules of the language—must be decoded for the 3D shape to emerge. Our vision is that both approaches must be strategically combined to define a new synergistic paradigm.

For the purposes of our review, we distinguish between the “artistic” branch of SBM, aimed at enabling input for 3D content creation, and the “engineering” one, aimed at facilitating engineering designs into CAD/CAM/CAE. The latter is the goal of this position paper. At a fundamental level, it may seem that the goal is the same in both cases (i.e. the generation of 3D models from sketches). However, we argue that the models produced for engineering design purposes must be composed of geometry that is fully controllable by the designer as well as the manufacturer who must manipulate and convert the model to make it usable for machining the corresponding physical part. These unique characteristics demand full control of the geometry and the size, including tolerances, as discussed in the seminal work by Shapiro and Voelcker [SV89].

The approaches and techniques developed for non-engineering models are somewhat useful but fundamentally different to the requirements of the approaches aimed at generating engineering CAD models from sketches. For example, the beautification of artistic sketches may prioritize softening contours by using freeform curves (e.g. [MSG20]). Engineering sketches, however, may be more concerned about identifying and precisely fixing the vertices where the sharp edges of a set of polyhedral faces meet. At a higher level, being able to detect manufacturing features (such as slots, drills, etc.) is critical in engineering sketches, whereas other types of features may be more relevant when working with artistic sketches (e.g. the eyes, nose, and mouth of a sketched character).

In our view, a key goal in CAD is the creation of models with a fully controllable geometry, or ‘dimensions-driven geometry’ [RSV89], and the ability to convey design intent, since the models evolve throughout the lifecycle of the product they represent. Our position is that although the ability to produce usable and controllable 3D geometry from engineering sketches has been accomplished to a certain extent, being able to extract know-how and design intent information (at a high semantic level) from the sketches and integrate it into the output CAD models remains a largely unexplored challenge.

To a great extent, this paper is a tribute to the seminal work of professor Herbert Bernhardt Voelker during the emergence of solid modeling, when sweep-CSG was proven superior to explicit B-Reps. Voelker and his colleagues contributed to enable the modification and reuse of models while conveying the original design intent [VR77], [RV82], [RV83], [RV85], [SV89], [Voe97].

The journey toward producing valid solids was not free from difficulties, as ensuring the consistency of the Boolean operations while allowing the re-parametrization and editing of sweeping operations often resulted in geometrical incoherencies, numerical instability, and even persistent naming problems, which Voelker contributed to solve. He had the vision to predict that history-based parametric geometry (now known as procedural CAD models) would become a key technology to produce the master geometry of engineering product models. Today, parametric CAD is a fundamental piece in engineering design ecosystem and has paved the way to new paradigms such as the Model-Based Enterprise. By building on Voelker’s seminal studies, we aim to provide designers and engineers with intuitive mechanisms to produce procedural CAD models through hand-drawn sketches, thus contributing to emerging fields such as custom manufacturing and personal fabrication.

3. Evolution of the keywords

In parallel with Sutherland's Sketchpad [Sut63], which was the first program that allowed the creation of graphical images directly on a computer screen using a light pen, Johnson's Sketchpad III added three-dimensional modeling capabilities to Sutherland's system [Joh63]. However, the first attempt to automatically perceive 3D shapes from 2D line drawings is attributed to Lawrence Roberts [Rob63].

The first comprehensive review on the topic, which was coined *line drawing interpretation*, was published by Sugihara [Sug86]. The review focused on geometry rather than perception, and the realizability of the drawings as projections of physically plausible 3D models. Two years later, authors Nagenda and Gujar published a comment on eleven papers on this topic published between 1973 and 1984, including a categorization tree [NG88]. Wang and Grinstein updated the categorization, and obtained a taxonomy of 3D object reconstruction from line drawings in two-dimensional projection [WG93]. The most recent comprehensive review, which was still geometry-centric, was authored by Martin Cooper [Coo08].

The problem of line-drawing interpretation turned into the problem of *geometric reconstruction* when researchers realized that "inverse projection" was the core procedure to produce 3D models from 2D line-drawings. The findings of this period were summarized by Company et al. [CPC05]. When it became evident that the problem could not be solved by purely geometrical approaches, the term SBM emerged, as described by Olsen et al. [OSC09] and Johnson et al. [JGH09].

The idea that producing 3D shapes from 2D drawings is not just a matter of geometry has been considered since the early days of SBM research. The pioneer work of Perkins, as part of Project Zero, analyzed how people perceive drawings that represent objects, which geometric relationships must be maintained, and the circumstances under which certain geometric relationships can be ignored [Per68], [Per71]. However, the idea only gained momentum when sketches began to displace line-drawings as input [LF11]. The evolution of the keywords in the fields related to SBM is illustrated in Figure 2.

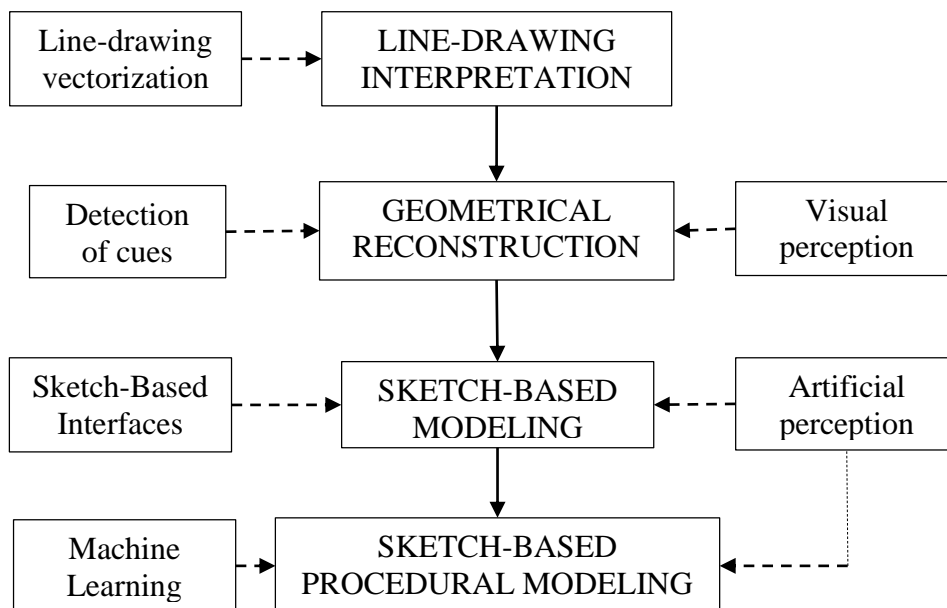

Figure 2. Evolution of SBM-related keywords

Producing 3D models from sketches is challenging, and will continue to be so. In a theoretical study, Goel examined the mental processes behind—and the messages conveyed by—engineering sketches and how to make these processes explicit [Goe95]. The author argued that most of the thoughts we convey through sketches remain non-computational because our current notions of computation and information representation are not rich enough to capture them.

In parallel to the use of sketches as input for producing 3D models, the question of whether sketches are useful for engineers and designers arises from time to time. It is obvious that not all designers use sketches, so some design strategies intentionally ignore them. However, sketches are valuable to most designers, and there is no shortage of evidence that shows how engineering sketches enhance creativity [Neg75], [UWC90], [Cug91], [Fer94], [DT95], [Ull02], [CRS13], [HGL18], [RD21]. The use of sketches for other types of interactions with computers eventually became part of the field of Sketch-Based Interfaces (SBI), which shares with SBM the input and most of its early processing (i.e. vectorizations of sketches to produce line-drawings), but diverges in the final output: a beautified vector-based drawing stored in electronic format in the case of SBI and a 3D CAD model in SBM. A survey on the topic was published by Cook and Agah [CA09]. Recent advances in related areas such as the contributions by Zeng et al. to modeling-by-recognition and sketch-based retrieval [ZLW14] [ZDY19] are out of the scope of this study, but should be monitored to leverage more than probable future synergies.

4. Stages in Sketch-Based Modeling

Various fields with their corresponding tools and techniques have emerged throughout the years based on the particular characteristics of the input and the output as well as the different stages used to divide the process. Input views are generally pictorial, but early attempts to reconstruct 3D models from orthographic views have also been made [NG88]. Recent contributions are due to Governì et al. [GFP13] and Han et al., who used multiple views that are not necessarily orthographic [HML20]. Pictorial views used as input are usually axonometric and single views, but some approaches based on perspective views can also be found in the literature [PCV13], [CVP14]. If the original drawing is created on paper, the electronic input can be obtained by scanning the drawing and producing a raster image, which is then *vectorized* as a series of strokes [WD99]. Converting a sketched input into discrete strokes (Figure 3) is a non-trivial task [HT06].

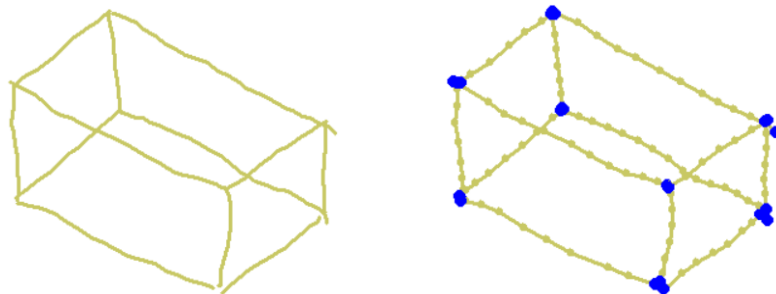

Figure 3. Sketches are hand-made drawings (left), which are made out of strokes (right)

The transition from old blueprints to CAD files was eventually resolved by manually recreating the drawings. However, this old goal of extracting information from blueprints (i.e. archaeological recovery of know-how) is still active, mostly in architecture [XWR09] [EVA20]. The advent of more sophisticated hardware devices to sketch directly with

computers also increased the interest in the automatic interpretation of sketches. Pen-based input (also known as Pen-driven computing, or simply *Pen Computing*) is a user-interface method that uses a pen and a touch sensitive screen (i.e. a tablet) over traditional input devices such as keyboard and mouse. Typing is replaced by handwriting, and menus are replaced by gestures. Although commercial libraries such as Microsoft's Tablet PC Platform SDK [JS02] implement handwriting and gesture recognition functionality (to a certain extent), they do not address the particular problems of input and interpretation of drawings. The task of converting an engineering drawing into a symbolic description was studied as part of *Sketch-Based Interfaces* [SSD01]. The most recent contributions replace tablets with hand-tracking sensors [KB16] and it has been suggested that combining tablet devices with augmented reality scenarios can enable new sketching approaches [XSC08].

The next stage in SBM is *converting strokes into lines*. To this end, some applications are available as public libraries such as Jorge and Fonseca's CALI [JF99]. The fundamental problem is the detection and calculation of strokes that convey straight and curved lines. The most relevant academic contributions are based on the Sparse Pixel Vectorization (SPV) algorithm [DW99]. The work by Bartolo et al. is particularly interesting as it described the problem of extracting lines from paper-based scribbled drawings [BCF08]. Company et al. recently discussed an approach to fit strokes as elliptical arcs (Figure 4). The approach was innovative since it balanced speed and precision, and output a figure of merit instead of a deterministic choice [CPV15]. Other approaches contributed to rough stroke cleanup [TTH19].



Figure 4. Fitting elliptical arcs to strokes

In order to successfully convert strokes into lines, strokes must have previously been grouped and/or broken down similarly to the way humans construe them. These tasks, which are perception-based, are known as *overtracing* and *segmentation*. *Interspersion* is also important for approaches that rely on the drawing sequence [KQW06], [SD08]. Other related techniques include gap detection, which aims to automatically identify and complete gaps in line drawings [SIS17].

A common strategy to solve segmentation is based on finding corners [XL10]. We note that interpreting overtracing in freehand sketches is considered a solved problem only for sketches that contain no auxiliary lines. We distinguish between different types of overtracing: (1) decoration (introducing shadows, textures, etc.), (2) thinking through the line (thinking about the design goal without stopping the tracing process), and (3) auto-correction (perceiving that the line is being drawn with error and trying to correct it on the fly). Overtracing for decoration conveys additional information (e.g. curvatures), while thinking and auto-correction overtracing should be interpreted as single lines [CV09]. Some approaches attempt to solve all overtracing and segmentation requirements simultaneously to output clean line-drawings [OK11], [LSR18]. Most of these techniques rely heavily on splines, which are common when sketching sculptured shapes (or interested in Matching Line Drawings and/or Sketch-Based Retrieval [LLX20] [NOD21]), but are commonly replaced by other primitive shapes (e.g. lines, elliptical arcs, etc.) while converting engineering shapes [GSH19], [WYI20]. Other approaches,

however, focus exclusively on a particular subproblem, such as detecting mirror symmetries [MLM01] [PCV16], perimeters [CVP17], or vertices [CVP19], [CPV19]. Most are more perceptual than geometric, as they assume the imperfect nature of sketches and try to infer one particular aspect of the intention of the drawing. A recent benchmark discussed the challenges that remain to be solved before we can “bridge the gap between sketches made in practice and a large literature of sketch processing algorithms” [YVG20]. An additional study described the differences between sketch and image processing [ZGZ20]. We note that the modern field of study in CAD sketch generation (e.g., [SZR21] [PBG21]) will likely influence future SBM developments at the stage of sketch-to-line-drawing conversion.

Once the input information is transformed into a vectorized line-drawing, the process of *inflation* is applied (Figure 5). *Inflation* is a classic approach to recover the depth information that is lost when a 3D model is depicted as a flat image. Two types of inflation exist, depending on the nature of the information. Takeo Igarashi is one of the best-known contributors to the approach of inflation or “fleshing out” *freeform shapes*. Indeed, his highly influential program TEDDY found many uses and inspired much follow-up work [IMT99]. CrossSketch [ASM07] makes use of Perkins’s Cubic Corners method, which previously had only been used to interpret drawings of analytical shapes. Liu and Lee made some minor improvements to the idea [LL10]. The current state of the art of input of engineering objects with functional curves is due to Wang et al. [WCL09], while Roth-Koch and Westkaemper gave some insight on their usefulness for engineering design purposes [RW10], and Xu et al. go beyond simple inflation by building on the idea that “designers leverage descriptive curves to effectively convey 3D information in 2D drawings” [XCS14] by parsing the sketch to find semantically rich information to prioritize it while inflating. The most recent survey was published by Ding and Liu, who categorized the approaches according to their input, knowledge used, modeling approach, and output [DL16].

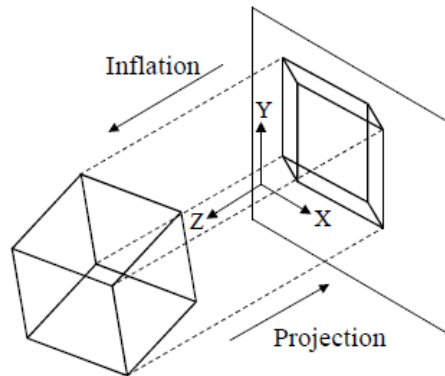

Figure 5. Inflation is the process of adding a third coordinate to the most critical/important points of flat drawings, in order to get them converted into 3D models.

Depending on the input, there are two separate research lines on inflation of *analytic shapes*: wireframe vs. natural line drawings. In the case of wireframe, Marill was the first researcher to use *optimization* approaches for inflation purposes [Mar91]. Leclerc and Fischler later introduced analytical formulations of some regularities in the input drawing [LF92] and Lipson and Shpitalni improved the approach and gave consistent formulations for a set of regularities [LS96]. Since optimization-based inflation does not always produce the desired model [LF92], [LS96], a type of pre- and post- inflation (or some “refinements”) may sometimes be necessary. For example, Clowes-Huffman’s *line*

labeling (catalogue labeling) is a well-established technique [Clo71] [Huf71]. Although line labeling was originally proposed as a method to identify and reject impossible drawings, it has many other uses and is often a useful input to inflation.

Departing from labeling approaches, Varley obtained practical solutions for natural line-drawing interpretation (Figure 6) by recreating a complete wireframe [Var03], [VMS05]. In an alternative approach, Suh modeled a 3D object as unions and intersections of extrusions [Suh07]. Azariadis et al. built on the Cross-Section Criterion of Ros and Thomas [RT05] to check the realizability of the sketched pictorial drawings [KAS11] [AKS13] and a recent contribution on finding hidden lines in a natural line-drawing is due to Bonnici and Camilleri [BC16]. Other recent contributions use alternative inflation methods which do not rely exclusively on projective geometry, but on perceptual rules [GHL20].

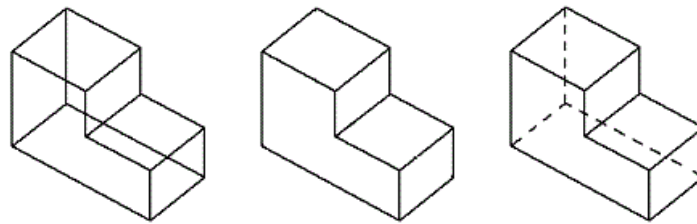

Figure 6. Natural (left), wireframe (center), and hidden lines (right) line-drawings.

It is important to emphasize that this review focuses on sketches that depict views of geometric shapes. Producing 3D models from *annotated* engineering drawings is an additional open problem that is out of the scope of this study. Although attempts have been made to interpret engineering drawings with annotations (e.g. [CAN08]), the state of the art can be traced back to the “classic” Ladder, by Hammond and Davis [HD03], and LaViola’s MathPad [Lav07]. The process (from annotated sketch to parametric model to physical manufactured part) is illustrated in Figure 7. Other developments use annotations to interact with virtual 3D models [SGL09].

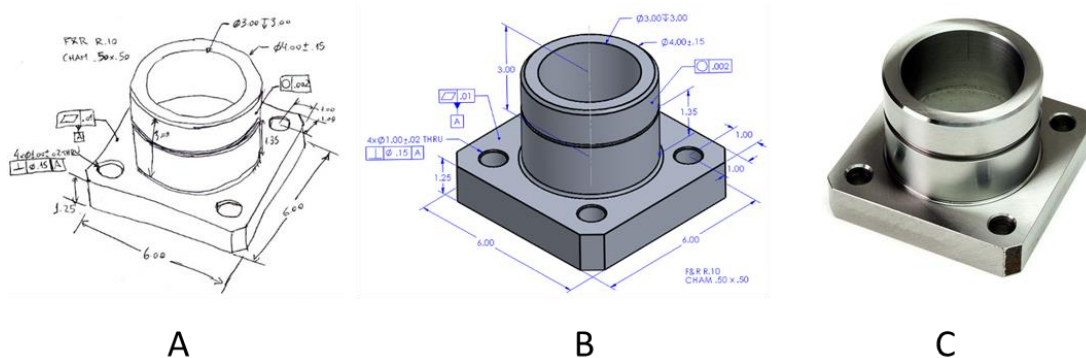

Figure 7. SBM of annotated models: 2D sketch (A), parametric feature-based CAD model (B), and machined part (C)

Annotations are used extensively in industrial settings to document the design of products. However, there is a gap between technology and practice. 3D annotations are mostly used in the same manner as 2D annotations in traditional engineering drawings, and not as truly semantic product information sources that are machine readable (i.e., interpretable by humans and consumable by computers with full traceability to the master

model). In addition, despite ongoing standardization efforts and the availability of more advanced model annotation tools, the theoretical frameworks in support of annotations to facilitate the communication and exchange of design information are far from the paradigm promoted by the MBE. In the context of this paper, handling annotations and producing annotated models from annotated sketches is challenging and should be considered a separate problem.

Finally, readers interested in a detailed comprehensive summary of SBM approaches, including specific strategies depending on the input type (single vs. multiple view, perfect line-drawings vs. sketched drawings, etc.), the output (B-Rep, vs CSG, etc.), and the type of interaction required, are referred to the studies by Company et al. [CPC05] and Olsen et al. [OSC09]. The goal of this paper is not to update these classifications, but to examine SBM through the lens of engineering design by strongly advocating for a research direction that involves a particular type of input (sketch) and output (CSG Procedural CAD models).

5. Design intent and Sketch-Based Modeling

The concept of Design Intent has been linked to CAD for decades. In the late 80's, Design Intent was associated with design constraints and the methods for manipulating these constraints during product design activities [KS89]. When CAD users (more specifically parametric solid modeling users) use the word “design,” they usually refer to modeling. In this context, design intent, generally speaking, is equivalent to Design for Change. Alternatively, design intent can be understood as a combination of geometry, psychology, and engineering (or shape, perception, and function), as discussed in the definition proposed by Company and Varley: “the set of intentions in sketches conveyed through cues, which, when perceived, reveal regularities or features of the object” [CV11]. In this section of the paper, we review the three aspects of design intent to highlight the bias associated to their dominance.

When geometry dominates, design intent is conveyed primarily through *geometric features*, which have been extensively studied as *regularities* [LS96], [YTJ08], [LLM10]. Nevertheless, even well studied cases of regularities, such as the detection of faces in wireframes of polyhedral objects, are not yet fully solved [MW80], [SL96], [LT05], [VC10].

When engineering dominates, design intent is conveyed primarily through *engineering features*. “Feature recognition” involves, for example, the detection of specific types of machined holes in a model, instead of simple cylindrical holes; or fillets and rounds, instead of blending surfaces. Feature recognition techniques have only been applied to SBM to a limited extent [CV10], [CVP12], [PVC13], [PCV14], [TK14], [TAH20], [TTA20]. A recent contribution by Plumed et al. [PVC22] provides a valid strategy that combines features through suitable datums and can define a complete and consistent CSG feature tree through the parent–child relationships between features. Datums are detected not only through geometrical procedures, but also using perceptual principles.

When psychology dominates, design intent is conveyed primarily through the application of strategies that replicate human perception. However, these strategies are challenging, as we do not fully understand all the intricacies of the mechanisms and processes involved in human perception. We perceive information that is not explicitly included in the drawings through *perceptual cues* (or *clues*). The work by Tversky shed light on this topic and debunked some false myths [ST97]. Other foundational readings on human

perception include Palmer's book [Pal99] and the "algorithmically oriented" approach proposed by Hoffman [Hof00].

Assigning meaning to what the eyes see is not a deterministic and immutable process. Since what we see has countless interpretations, the perceptual system uses *principles* (defined as "fundamental truths or propositions that serve as the foundation for a system of belief or behavior or for a chain of reasoning"). According to some authors, these propositions are considered "principles" as they are weaker than expected for a scientific law [Pal99]. Principles can be developed into *rules* ("a prescribed guide for conduct or action") to interpret visual information. As a result, the rules are similar to pseudocode for an algorithmic approach to visual perception. We use the notion of *cue*, as a visual stimulus that, when perceived, reveals regularities or features of the object. It can be considered a natural or unintended sign. According to the American Psychological Association [APA], a *perceptual cue* is a "feature of a stimulus that is perceived and used by an organism in a particular situation or setting to identify and make judgments about that stimulus and its properties." Cues depend on the type of input. For example, shading has been successfully used as a cue to determine depth in orthographic views [CFG17].

In the early twentieth century, Austrian and German psychologists Max Wertheimer, Kurt Koffka, and Wolfgang Köhler sought to explain human visual perception and how our brain processes visual information. Their findings, known as *Gestalt Principles of Visual Perception*, describe the basic organizational structures that our brain imposes on the visual inputs. "Gestalt" is a German word for "shape." Today, Gestalt psychology is considered a descriptive framework of visual perception, rather than a rigorous explanatory theory. Nonetheless, designers involved in the development of artifacts for human use often adopt the simple principles of Gestalt psychology. The relationship between Gestalt psychology and design seems reasonable as designed products are created to interact with users, and both designing and perceiving are cognitive activities. During its operational years in the early 20th century, the iconic Bauhaus design school in Germany stressed the duality *form-function*. Barbara Veigl wrote, "Although till now no direct relation between the work of the Bauhaus and Gestalt theory has been demonstrated, many points of contact are obvious – e.g. questions about the connection between matter (form) and function (content)" [Veigl11]. In other words, both schools of thought share the idea that we always experience organized wholes, instead of isolated parts or the mere sum. Indeed, sometimes the whole is different from the sum of its parts. Therefore, it is not strange that the Gestalt principles guide our understanding of how designed products "communicate" with users.

Cognitive psychologist Donald Hoffman [Hoff00] disaggregated the main principles of perception into detailed rules. These rules are almost an algorithmic description to determine the likelihood of each visual cue to convey a type of feature. According to Hoffman, a total of twenty rules describe the way we perceive shapes. The rules are obtained by breaking down the principles of generic views, projection, proximity, etc. into smaller facets. Each rule covers a particular facet of a principle. Therefore, a principle can be fully defined by a group of rules. The rules are not a complete set, nor are they free of controversy, but they provide valuable insight not only for explaining that we construct what we see, but also as a theoretical basis for simulating and replicating visual perception algorithmically.

6. A Synergistic Approach to SBM Research

The main goal of our research is the development of automated mechanisms that can produce—or at least, facilitate the creation of—parametric solid CAD models from hand-drawn engineering sketches. Although various attempts to interact with computers via SBM interfaces have been proposed, no practical applications are yet available in engineering.

Unfortunately, interest in SBM research is decreasing perhaps because computer scientists have found other topics (such as the recognition and reconstruction of real-world scenes from images captured by cameras) and engineers feel reasonably comfortable with the current mechanical CAD paradigm and fail to recognize the potential benefits of interacting with computers via sketches. An exception is gesture-based interfaces, such as gestural applications for 3D sketching in augmented and virtual reality environments. Nevertheless, the idea of building 3D models from sketches may lead to a new, more natural and intuitive design paradigm as long as suitable tools are developed. Emerging trends such as personal fabrication and the democratization of design and manufacturing can particularly benefit from these advances [Fox14], [BM17], [LEM17].

In this regard, the two dominant SBM approaches (inflating and perceiving/reading) have proven to be insufficient by themselves. Information needs to be decoded to guide the inflation approach, and perceiving/reading indirect or implicit geometric information encoded in a drawing is not enough if we ignore the invariant geometric information of the model that contains the drawing and the invariants of the drawing itself. Therefore, we argue that both approaches are part of a comprehensive approach where the weight of each strategy does not depend on a priori decisions, but on the particular characteristics of the input.

In addition, interpreting hand-drawn sketches is more challenging than processing line drawings because the geometric information is imperfect or may even be corrupted. Encoded information is usually less explicit, as sketches are not self-contained documents. They are often incomplete since they are usually linked to conceptual design stages where the design problem is still poorly defined.

In our view, the next contributions in the field of model reconstruction must come from feature detection in sketches and then using these features to create a model tree that describes a procedural feature-based CAD model. We advocate that mental processes can be understood as information processing events. This idea began to emerge in the 1950s with the advent of computer science and information theory. The synergy between the two fields allowed psychologists to develop a framework for understanding visual perception as an input that is processed by our brains to produce an output. Our visual system supplements the optical information with a number of plausible assumptions. In this paradigm, perception is a type of cognition. However, not all stimuli that generate a signal in our nervous system are processed for meaning. We ignore most of the information around us and only pay attention to a small, selected amount. Therefore, we promote an SBM approach where not all the information provided by the sketches is given the same reliability and credibility, neither is it processed in the same manner.

The problem is that the cognition strategies to process visual information for meaning are not obvious. Clearly, we do not react the same way to different stimuli. For instance, humans are sensitive to patterns rather than intensity, and abrupt changes are more easily perceived than gradual changes. What are the rules that influence our perception? What

are the intrinsic elements in a visual scene that determine how we perceive a certain stimulus? How do these elements interact with each other to elicit a specific perceptual response? The *grammar of vision* is the study and use of the rules that govern how the various elements of an image influence how it is perceived and how they combine and interact with other elements to make sense to our perceptual system.

The principles and rules must not be viewed as “hard” or “mandatory.” Instead, they should be considered “soft,” or “probable” guides. Psychologists call them *ceteris paribus* rules, meaning that they are likely true when all else is equal. In fact, they may sometimes contradict each other, resulting in perceptual conflicts that are solved by prioritizing the most probable. It appears that, under contradictory cues, the perceptual system assigns “figures of merit” that estimate how likely each cue is to convey an actual feature. *Multi-stability* is an example of this situation. It can be illustrated by the famous Necker’s cube, which accepts two different but equally valid interpretations that alternate in our perceptual system every few seconds (Figure 8).

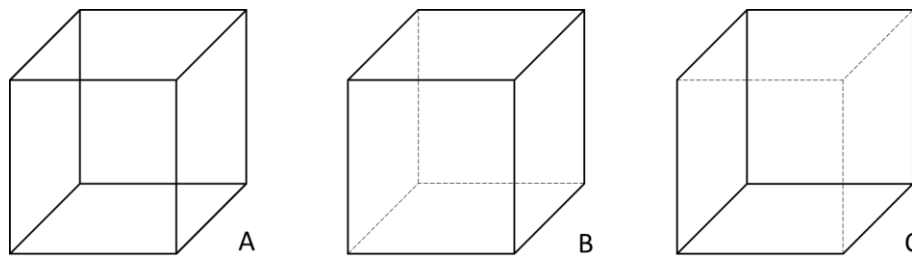

Figure 8. Necker’s cube (A), and the two spatial interpretations (B and C).

In our view, once parametric features can be reconstructed from input sketches to output procedural CAD models, research should also focus on the challenging problem of producing *quality* CAD models directly from sketches.

CAD model quality can be characterized at three levels: usability (which encompasses validity and completeness, as defined in [CCO15]), reusability (consistency and conciseness), and semantic (clarity and the ability to convey design intent). Current approaches to CAD quality are limited to validity, ensuring that the CAD model does not contain topological or geometric errors. Generally speaking, completeness implies that the model replicates the shape and size of the product. In a broader sense, however, completeness involves addressing all product requirements. Conciseness and clarity are aimed at facilitating CAD model reusability [AJA21]. Finally, there is a relatively recent, and moderately extended tendency to consider the manner in which CAD models convey design intent [OCC18]. Some authors focus on the differences between declarative, procedural and strategic knowledge [DTS12] [DSD20], which clearly resonates with the three levels (*using, reusing, and conveying* design intent) discussed previously.

Currently, the output of SBM systems is limited to “dumb models” (mainly B-Rep), a representation that lacks the semantic level required to enable reusability and convey design intent in engineering design applications. The dominant representation in CAD is procedural, history-based, feature-based, and parametric. Naturally, future SBM approaches should target the generation of this type of procedural CAD models directly from design sketches (Figure 9).

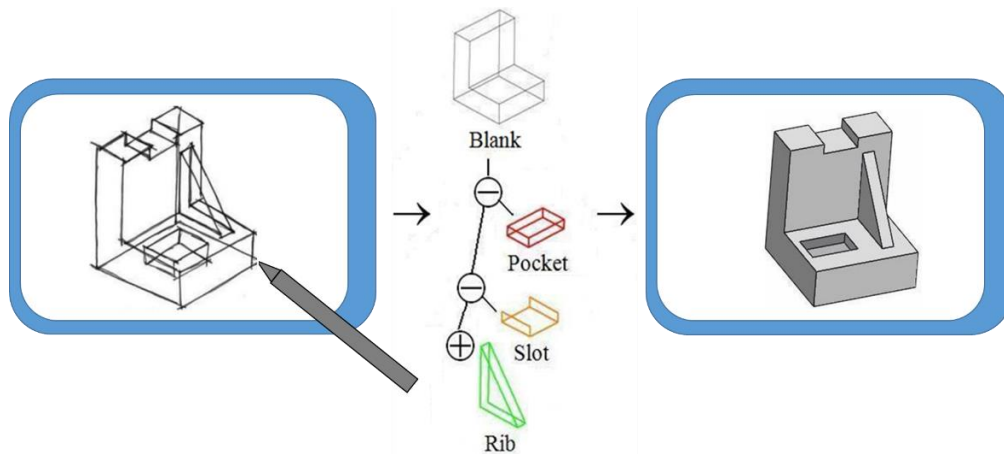

Figure 9. From sketches to procedural CAD models.

Managing the quality of CAD models involves enabling both explicit and implicit quality information exchange. The exchange should not be limited to CAD systems, but made available to all downstream applications (CAE, CAM, etc.). In our view, this capability can be leveraged by detecting, managing, and exchanging *design requirements*.

From an educational standpoint, it has been argued that learning strategies that focus on modeling geometry from detailed design drawings are useful, but somewhat unrealistic. Although these strategies facilitate the uncoupling of the CAD operation from conceptual design tasks, they do not prepare trainees for more realistic scenarios where models are not created from detailed design drawings but from incomplete and sometimes contradictory sets of design criteria, which get refined when the conceptual design becomes a detailed design. In other words, designs are realized by building tentative models which iteratively get refined into final models, i.e. *tentative specifications* are eventually refined into *final requirements*.

Due to the limitations of current CAD paradigms, industrial approaches to engineering design often mimic academic approaches where conceptual design is primarily done without computers. Computers are helpful for completing the requirements stage only after the design is sufficiently refined. Requirements development implies writing clear, simple, and testable specifications that describe an industrial product. Thus far, systems engineering has been practiced “without much tooling, typically facilitated by exchanging engineering memos, mechanical drawings and sketches, and spreadsheets” [BCZ16]. However, computers could aid during the conceptual design stage by leveraging the information contained in the design sketches [CCV09] [KA21]. As we already discussed, conceptual sketches are commonly used to explore design ideas and make decisions by conveying geometric representations (supported by more or less formal annotations), to quickly and explicitly communicate design alternatives and how design requirements are met.

Ideally, SBM tools should be able to “read” hand-drawn design sketches and automatically produce detailed parametric CAD models [PVC13] [PVC22]. In other words, even informal and unstructured specifications conveyed through ideation sketches could eventually trigger the automatic (or semi-automatic) creation of CAD models and assemblies, which are critical in a model-based design process. If we manage to detect high semantic level information in sketches (i.e. we can detect the design/manufacturing features), we should next be able to build a procedural model. According to the conclusions by Hartquist et al. “one can arrive at effective implementations of

applications involving offsets, sweeps, and Minkowski operations (by (1) focusing on the computational requirements intrinsic to the application, (2) using direct approximations of relevant mathematical definitions, and providing copious computing resources, so that implementations can be designed for simplicity, clarity, and robustness, rather than simply for resource conservation (i.e. classical efficiency)” [HMS99].

Indeed, recent publications advocate that “training machine learning models to reason about and synthesize parametric CAD designs has the potential to reduce design time and enable new design workflows” [SOZ20].

While mathematically a sketch has an infinite number of potential interpretations, cognitively, engineers can immediately recognize which interpretation is the intended one. In this regard, the training of machine learning (ML) algorithms seems to be a natural approach to SBM. However, there is an open debate on whether ML can handle tasks that require not only ingenuity (mechanics) but also intuition (mind) [Lar21]. Even if we assume that ML approaches apply to SBM, some critical problems must be addressed. A significant problem is that the data sets required to properly train these algorithms are either not available, or they include models of low semantic quality [GCC17].

Current ML efforts in SBM are primarily intended for recovering models from sketches, and the most effective strategy (e.g., convolutional neural networks, generative adversarial networks, etc.) is yet to be determined. For example, in their approach, authors Liu et al. [LDL19] do not complete the object, but recover any missing parts of the sketch using generative adversarial networks (GAN). The approach by Seff et al. [SZR21] “trained on real-world designs from the SketchGraphs dataset, autoregressively synthesizes sketches as sequences of primitives, with initial coordinates, and constraints that reference back to the sampled primitives.”

The current limitations of SBM can be summarized by the fact that the thoughts we convey through sketches remain non-computational because our current notions of computation and information representation are not sufficiently rich to capture them. Machine Learning (ML) is a promising approach to overcome this limitation, but the use of low-quality CAD models to train an ML algorithm will inevitably result in intelligent systems that mimic the low-quality models that, unfortunately, are commonplace in industry [GCC17]. Indeed, the use of high-quality models is critical for training an ML system. We cannot limit ourselves to generating low-quality CAD models from sketches, as high-quality and semantically rich models are paramount. To this end, we suggest an alternative development of the SBM paradigm that focuses on capturing richer semantic information (design features) and training ML algorithms to interpret engineering sketches as quality CAD models.

As a related area of study, the creation of precise geometry by “sketching” in a VR environment has been gaining interest in recent years. Research and development have followed mainly two distinct approaches [CGM19]: (1) creating a VR front-end to interact with a CAD system or provide 3D modeling functionality via a geometric kernel [MMO17] [FWS18], and (2) directly supporting 3D sketching for VR. For example, Machuca et al. [MAS18] proposed a VR-based environment for 3D freehand drawing that automatically beautifies strokes to compensate for the difficulty of drawing in 3D. In a subsequent study, the authors proposed Smart3DGuides [MSA19], a mechanism to automatically provide visual assistance by analyzing the user’s gaze, controller position and orientation and previous strokes in the VR environment, to increase the overall quality of the drawn shapes. Other approaches include gesture-free methods [VR15] and mixed-reality strategies for the direct creation of 3D shapes on and around physical

objects using the ‘sketch-and-inflate’ scheme [HR16]. In all cases, these VR-based sketching environment use models that are not procedural.

The use of SysML to represent a system architecture has been acknowledged as a successful approach to subsequently combine design requirements with CAD information, thus enabling true model-based engineering [BCZ16]. Open problems related to this approach have been identified, such as the need for parametrized CAD models, and the difficulty to harmonize the different levels of abstraction between the system architecture and the CAD models. Some authors have even argued that annotating models is not always the most efficient strategy [BJ20]. In the short term, defining a prototype of requirements-guided CAD, where design requirements inform the development of parametrized CAD models has shown promise [CCC17].

Machine learning techniques can be leveraged to process quality CAD models and extract their implicit design knowledge (Figure 10). The procedure is similar to the one described by Willis et al. to reconstruct procedural CAD models based on sketch and extrude operations [WPL20]. We also suggest the applications of Knowledge Based engineering (KBE) principles, which are effective for capturing and re-using engineering knowledge and automating large portions of the design process [Lar12]. This approach would enable a formal representation of good modeling practices by distilling the key properties of quality CAD models. Nonetheless, there is a lack of specialized data sets required to effectively train ML algorithms [KGR21] in SBM.

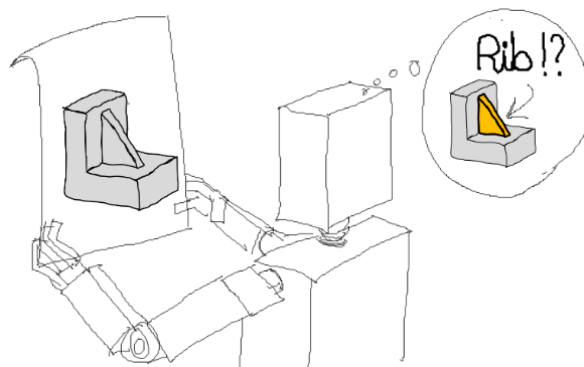

Figure 10. The automatic perception of geometric features may evolve toward the automatic perception of design requirements.

7. Conclusion

The review on SBM presented in this paper builds on the contributions of professor Herbert Bernhardt Voelker to the field of solid modeling. More specifically, Voelker and his colleagues paved the way to enable the modification and reuse of procedural CAD models while keeping their original design intent, thus making this type of models a key technology to build the master geometry of engineering product models. The paradigm is commonly used in relationship to products with a strong mechanical basis, for which mechanical CAD applications (MCAD), usually parametric and history-based, are used.

In this paper, we examine procedural CAD through the lens of SBM in an effort to provide designers and engineers with intuitive mechanisms to produce these models through hand-drawn sketches. We build on the idea that two different branches of SBM coexist. Despite their similarities, one is geared toward “artistic” purposes and the other is governed by “engineering” principles. We argue that they must be studied separately, because of the fundamentally different goals of artistic vs. engineering sketches.

Indeed, the current states-of-the-art of these two fields are very different. While the automatic conversion of artistic sketches into 3D models is currently an active area of research that has made significant progress in recent years, the problem of producing CAD models with controllable geometry is only partially solved, and comparatively it has not yielded many significant contributions to the scholarly literature recently. Being able to generate semantically rich parametric feature-based engineering models from hand-drawn design sketches is a challenging open problem. In this regard, producing B-Rep models is a poor result, as this type of models do not embed engineering design intent or include the know-how information that is implicit in the model tree of a procedural CAD models.

Historically, many research efforts focused on reconstructing line drawings, mainly because line drawings are simpler to process than sketches, and because there was a practical problem to solve: industry was migrating from blueprints (many of which contained the know-how and the detailed information of active long-term projects) to 3D CAD files. The transition from old blueprints to CAD files was eventually resolved by manually recreating the drawings, so *interpreting* sketches became the new main goal.

Although many SBM tools have been developed over the years, designers are reluctant to use them. Available user studies have shown that current SBM tools are not as usable as traditional paper and pencil sketches, and they do not provide any significantly improved functionality [CA09]. User interfaces for SBM have been developed to some extent, but more work is required as discussed in the review conducted by Johnson et al. [JGH09].

In our view, future SBM approaches for engineering design must consider Qualitative Reasoning techniques to manage perceived rules, in order to produce tentative design features, which can be later refined by applying geometric rules. Engineers and designers (“the users”) should push researchers and developers toward the detection of cues of higher semantic level, which are intended to disclose more sophisticated design features and complex Boolean combinations, which should result in quality CAD models generated from design sketches. Furthermore, the exchange of high-quality CAD models can conceivably be replaced by the exchange of high semantic level design requirements. Exchanging requirements instead of models is advantageous at various levels. First, it would allow governing the creation of quality CAD models by preventing the validation and acceptance of non-conforming models. Second, the new paradigm would replace the current exchange of “snapshot” models (i.e. static models that only reflect a particular moment in the evolution of a product) with evolving frameworks that describe the design intent of modeled parts and adapt to the changing scenarios that models must face when products are being refined or redesigned.

8. References

- [AJA21] Aranburu A., Justel D., Angulo I. (2021) Reusability and Flexibility in Parametric Surface-based Models: A Review of Modelling Strategies. *Computer-Aided Design & Applications*, 18(4), 2021, 864-874. DOI: 10.14733/cadaps.2021.864-874.
- [AKS13] Azariadis P., Kyratzi S., Sapidis N. (2013) A Hybrid-Optimization Method for Assessing the Realizability of Wireframe Sketches. *3D Research* 4(1), Article 3, pp. 1-11. DOI: 10.1007/3DRes.01(2013).

- [APA] American Psychological Association. Dictionary of Psychology. Perceptual cues. <https://dictionary.apa.org/perceptual-cues>.
- [ASM07] Alexis A., Suguru S. and Masayuki N. (2007) CrossSketch: freeform surface modeling with details SBIM '07 Proceedings of the 4th Eurographics workshop on Sketch-based interfaces and modeling.
- [BC16] Bonnici A., Camilleri K. (2016) An Evolutionary Approach to Determining Hidden Lines from a Natural Sketch. IEEE Symposium on Visual Languages and Human-Centric Computing (VL/HCC 2016). Volume 1, pp. 26-30. DOI Bookmark: 10.1109/VLHCC.2016.7739660.
- [BC20] Bhattacharjee S., Chaudhuri P. (2020) A Survey on Sketch Based Content Creation: from the Desktop to Virtual and Augmented Reality. Computer Graphics Forum 39(2), pp. 757-780. DOI: 10.1111/cgf.14024
- [BCF08] Bartolo A. Camilleri K.P. Fabri S.G. Borg J.C. (2008) Line tracking algorithm for scribbled drawings. Communications, Control and Signal Processing, 2008. ISCCSP 2008. 3rd International Symposium on , vol., no., pp.554-559, 12-14. DOI: 10.1109/ISCCSP.2008.4537287.
- [BCZ16] Bajaj M., Cole B., Zwemer D. (2016) Architecture to Geometry - Integrating System Models with Mechanical Design. AIAA 2016-5470. Session: Model-Based Systems Engineering: Methodologies and Tools I. Published Online: 9 Sep 2016. DOI: 10.2514/6.2016-5470.
- [BJ20] Bowden M., Jones M. (2020) The Cost of Enabling the Digital Thread. Proc. of the 11th Model-Based Enterprise Summit (MBE 2020), Gaithersburg, Maryland, USA, March 31 - April 2, pp. 41-48. DOI: 10.6028/NIST.AMS.100-29#page=51.
- [BM17] Baudisch P., Mueller S. (2017), Personal Fabrication, Foundations and Trends. Human-Computer Interaction: Vol. 10: No. 3-4, pp 165-293. <http://dx.doi.org/10.1561/11000000055>.
- [CA09] Cook M.T., Agah A. (2009) A survey of sketch-based 3-D modeling techniques. Interacting with Computers, 21, pp. 201-211. DOI:10.1016/j.intcom.2009.05.004
- [CAN08] Company P., Aleixos N., Naya F., Varley P.A.C., Contero M. and Fernandez-Pacheco D.G. (2008) A New Sketch-Based Computer Aided Engineering Pre-Processor. *Proc. Sixth Int. Conf. on Engineering Computational Technology*. Civil comp Ltd. Paper-149.
- [CCC04] Company P, Contero M, Conesa J, Piquer A. (2004) An optimisation-based reconstruction engine for 3D modeling by sketching. *Computers & Graphics*; 28(6): 955-979.
- [CCO15] Company P., Contero M., Otey J. and Plumed R. (2015) Approach for developing coordinated rubrics to convey quality criteria in MCAD training. *Computer-Aided Design*. Vol. 63, 101-117.
- [CCV09] Company P., Contero M, Varley P.A.C. Aleixos N. and Naya F. (2009) Computer-Aided Sketching as a Tool to Promote Innovation in the New Product Development Process. *Computers in Industry*, 60 (8), pp. 592-603. 2009. DOI: 10.1016/j.compind.2009.05.018.

- [CCC17] Camba J.D., Contero M. Company P. and Pérez D. (2017) On the Integration of Model-Based Feature Information in Product Lifecycle Management Systems. *International Journal of Information Management* (ISSN 0268-4012). 37(6), pp. 611–621.
- [CFG17] Carfagni, M., Furferi, R., Governi, L., Volpe, Y. (2017) 3D geometry reconstruction from orthographic views: An improved method exploiting shading information. *Computers in Industry* 92-93, pp. 137-151. DOI: 10.1016/j.compind.2017.07.001
- [CGM19] Cordeiro, E., Giannini, F., Monti, M. (2019) A survey of immersive systems for shape manipulation. *Computer Aided-Design and Applications*, 16, 1146–1157.
- [Clo71] Cloves M.B. (1971). On seeing things. *Artificial Intelligence*, 2, 76-116
- [Coo08] Cooper M. *Line drawing interpretation*. Springer, 2008. ISBN: 978-1-84800-228-9.
- [CPC05] Company P., Piquer A., Contero M., Naya F. (2005) A Survey on Geometrical Reconstruction as a Core Technology to Sketch-Based Modeling. *Computers & Graphics* 29 (6) 892-904.
- [CPV15] Company P., Plumed R. and Varley P.A.C. A fast approach for perceptually-based fitting strokes into elliptical arcs. *The Visual Computer Journal* (ISSN 0178-2789 (Print) 1432-2315 (Online)). Vol. 31, Issue 6, (2015), pp. 775-785. DOI: 10.1007/s00371-015-1099-6
- [CPV19] Company P., Plumed R., Varley P.A.C., Camba J.D. (2019) Algorithmic Perception of Vertices in Sketched Drawings of Polyhedral Shapes. *ACM Transactions on Applied Perception* (ISSN: 1544-3558, eISSN: 1544-3965). Vol. 16, Issue 3. Article No. 18. pp. 1-19. DOI: 10.1145/3345507
- [CRS13] Chandrasegaran S.K., Ramani K., Sriram R.D., Horvath I., Bernard A., Harik R.F., Gao W. (2013). The evolution, challenges, and future of knowledge representation in product design systems. *CAD Computer Aided Design*, 45(2), pp. 204-228. DOI: 10.1016/j.cad.2012.08.006.
- [Cug91] Cugini U. (1991) The problem of user interface in geometric modeling. *Computers in Industry*, 17(4), pp. 335-339. DOI: 10.1016/0166-3615(91)90045-B.
- [CV09] Company P. and Varley P.A.C. (2009) Operating modes in actual versus virtual paper-and-pencil design scenarios. *Intelligent User Interfaces (IUI) Workshop on Sketch Recognition*, 2009.
- [CV10] Company P. and Varley P.A.C. (2010) A Method for Reconstructing Sketched Polyhedral Shapes with Rounds and Fillets. R. Taylor et al. (Eds.). *Lecture Notes in Computer Science. Smart Graphics 2010 Proceedings*. Volume 6133. 2010, pp 152-155.
- [CV11] Company P. and Varley P.A.C. “Sketch Input of Engineering Solid Models” Eurographics 2011. Tutorial 2. Llandudno, April 11th 2011. Part 1 Part 2 Part 3 Part 4
- [CVP12] Company P., Varley P.A.C., Plumed R., and Martin R. Perceiving Ribs in Single-View Wireframe Sketches of Polyhedral Shapes. G. Bebis et al. (Eds.): ISVC 2012, Part II, Advances in Visual Computing, LNCS 7432, pp.

- 557-567. Springer, Heidelberg (2012). DOI: 10.1007/978-3-642-33191-6_55
- [CVP14] Company P., Varley P.A.C., Plumed R. An Algorithm for Grouping Lines Which Converge to Vanishing Points in Perspective Sketches of Polyhedra. *Graphics Recognition. Current Trends and Challenges. B. Lamiroy and J.-M. Ogier (Eds.): GREC 2013, LNCS 8746, pp. 77–95, 2014.* DOI: 10.1007/978-3-662-44854-0_7
- [CVP17] Company P., Varley P.A.C., Plumed R. (2017). Perimeter detection in sketched drawings of polyhedral shapes. Eurographics, 2017 Italian Chapter Conference, STAG: Smart Tools and Applications in Graphics (ISBN 978-3-03868-048-2). pp. 23-29. DOI:10.2312/stag.20171223
- [CVP19] Company P., Varley P.A.C., Plumed R. (2019). Detection of Vertices in Sketched Drawings of Polyhedral Shapes. CIARP 2018, LNCS 11401, pp. 376–383. DOI: 10.1007/978-3-030-13469-3_44.
- [DL16] Ding C., Liu L. (2016) A survey of sketch based modeling systems. *Front. Comput. Sci.*, 2016, 10(6): 985–999. DOI 10.1007/s11704-016-5422-9.
- [DT95] Dori D., Tombre K. (1995) From engineering drawings to 3D CAD models: are we ready now?. *Computer-Aided Design*; 27(4): 243-254
- [DSD20] Delahunty T., Seery N., Dunbar R., Ryan M. (2020) An exploration of the variables contributing to graphical education students' CAD modelling capability. *International Journal of Technology and Design Education* 30:389–411. DOI: 10.1007/s10798-019-09503-x.
- [DTS12] Daud M.F., Taib J.M., Shariffudin R.S. (2012) Assessing Mechanical Engineering Undergraduates' Conceptual Knowledge in Three Dimensional Computer Aided Design (3D CAD). *Procedia - Social and Behavioral Sciences* 56, pp 1–11. DOI: 10.1016/j.sbspro.2012.09.626.
- [DW99] Dori, D. and Wenyin Liu. (1999) Sparse pixel vectorization: an algorithm and its performance evaluation, *Pattern Analysis and Machine Intelligence*, IEEE Transactions on , vol.21, no.3, pp.202-215. DOI: 10.1109/34.754586.
- [EVA20] Egiazarian V., Voynov O., Artemov A., Volkhonskiy D., Safin A., Taktasheva M., Zorin D., Burnaev E. (2020). Deep Vectorization of Technical Drawings. *European Conference on Computer Vision (ECCV 2020)*, pp 582-598. DOI: 10.1007/978-3-030-58601-0_35.
- [Fer94] Ferguson E.S. *Engineering and the Mind's Eye*. Cambridge, MA: The MIT Press, 1994.
- [Fox14] Fox S. (2014) Third Wave Do-It-Yourself (DIY): Potential for prosumption, innovation, and entrepreneurship by local populations in regions without industrial manufacturing infrastructure. *Technology in Society*, 39, pp. 18-30. DOI: 10.1016/j.techsoc.2014.07.001.
- [FWS18] Feeman, S.M., Wright, L.B., Salmon, J.L. (2018) Exploration and evaluation of CAD modeling in virtual reality. *Computer Aided Design and Applications*,15, 892–904.
- [GCC17] González-Lluch C., Company P., Contero M., Camba J.D., and Plumed R. (2017) A Survey on 3D CAD Model Quality Assurance and Testing Tools.

- Computer-Aided Design, 83, pp. 64-79. 2017. DOI: 10.1016/j.cad.2016.10.003.
- [GFP13] Governi, L., Furferi, R., Palai, M., Volpe, Y. (2013) 3D geometry reconstruction from orthographic views: A method based on 3D image processing and data fitting. *Computers in Industry*, 64(9), pp. 1290-1300.
- [GHL20] Gryaditskaya Y., Hähnlein F., Liu C., Sheffer A., Bousseau A. (2020) Lifting freehand concept sketches into 3D. *ACM Transactions on Graphics*, 39(6),167. Doi: 10.1145/3414685.3417851.
- [Goe95] Goel V.(1995) *Sketches of Thought*. The MIT Press.
- [GSH19] Gryaditskaya Y., Sypesteyn M., Hoftijzer J.W., Pont S., Durand F., Bousseau A. (2019) OpenSketch: A Richly-Annotated Dataset of Product Design Sketches. *ACM Transactions on Graphics*, 38(6),3356533.
- [HD03] Hammond T., and Davis R. 2003. Ladder: A language to describe drawing, display, and editing in sketch recognition. *Proc. of the 2003 Int. Joint Conference on Artificial Intelligence (IJCAI)*.
- [HGL18] Hilton E.C., Gamble T., Li W., Hammond T., Linsey J.S.(2018) Back to basics: sketching, not CAD, is the key to improving essential engineering design skills. In: ASME 2018, International Design Engineering Technical Conferences and Computers and Information in Engineering Conference, p. V007T06A051–V007T06A051.
- [HML20] Han, Z., Ma, B., Liu, Y.-S., Zwicker, M. (2020) Reconstructing 3D Shapes from Multiple Sketches Using Direct Shape Optimization. *IEEE Transactions on Image Processing*, 29, 9184255, pp. 8721-8734.
- [HMS99] Hartquist E.E., Menon J.P., Suresh K., Voelcker H.B., Zagajac J. (1999) A Computing strategy for applications involving offsets, sweeps, and Minkowski operations. *Computer Aided Design*, 31(3), pp. 175–183. Doi: 10.1016/S0010-4485(99)00014-7.
- [Hof00] Hoffmann D. *Visual Intelligence. How we create what we see*, New York: WW Norton & Company, 2000.
- [HT06] Hilaire X. and Tombre K. (2006) Robust and accurate vectorization of line drawings. *IEEE Trans. Pattern Analysis and Machine Intelligence*, 28 (6), pp. 890-904.
- [Huf71] Huffman D.A. (1971). Impossible objects as nonsense sentences. *Machine Intelligence*, 6, pages 295-323.
- [HR16] Huo, K., Ramani, K. (2016). Window-Shaping: 3D Design Ideation in Mixed Reality. In *Proceedings of the 2016 Symposium on Spatial User Interaction*, pp. 189-189.
- [IMT99] Takeo Igarashi, Satoshi Matsuoka, Hidehiko Tanaka. Teddy: A Sketching Interface for 3D Freeform Design. *ACM SIGGRAPH 99 (Impact Paper)* Los Angeles, August 1999.
- [JF99] Jorge J.A. and Fonseca M.J. (1999) A Simple Approach to Recognize Geometric Shapes Interactively. *GREC 1999: Graphics Recognition Recent Advances. Lecture Notes in Computer Science*, vol 1941, pp 266-274. DOI: 10.1007/3-540-40953-X_23.

- [JGH09] Johnson G., Gross M.D., Hong J. and Do E.Y. (2009) Computational Support for Sketching in Design: A Review. *Foundations and Trends in Human-Computer Interaction*. 2 (1), pp. 1–93.
- [Joh63] Johnson TE. (1963) Sketchpad III, three dimensional graphical communication with a digital computer. PhD Thesis. M.I.T., Cambridge, MA USA
- [JS02] Jarret R. and Su P. Building Tablet PC applications. Microsoft Press, 2002.
- [KA21] Kyratzi S., Azariadis P. (2021) A Constraint-based Framework to Recognize Design Intent during Sketching in Parametric Environments. *Computer-Aided Design & Applications*, 18(3), 2021, 545-560. DOI: 10.14733/cadaps.2021.545-560
- [KAS11] Kyratzi S., Azariadis P., Sapidis N. (2011) Realizability of a Sketch: An Algorithmic Implementation of the Cross-Section Criterion”, *Computer-Aided Design & Applications* 8(5), pp. 665-679. DOI: 10.3722/cadaps.2011.665-679.
- [KB16] Kim Y., Bae S.H. (2016) SketchingWithHands: 3D Sketching handheld products with first-person hand posture. *UIST 2016 - Proceedings of the 29th Annual Symposium on User Interface Software and Technology* 16 October 2016, Pages 797-808; Code 124327.
- [KGR21] Kim S., Chi H., Ramani K. (2021) Object Synthesis by Learning Part Geometry with Surface and Volumetric Representations, *Computer-Aided Design*, 130, 102932. DOI: 10.1016/j.cad.2020.102932.
- [KKK03] Khalid S Khan, Regina Kunz, Jos Kleijnen, Gerd Antes (2003) Five steps to conducting a systematic review. *Journal of the Royal Society of Medicine*. 2003 Mar;96(3):118-21. DOI: 10.1258/jrsm.96.3.118.
- [KQW06] Ku D.C., Qin S.F. and Wright D.K. (2006) Interpretation of Overtracing Freehand Sketching for Geometric Shapes. *WSCG'2006*
- [KS89] Kimura F. and Suzuki H. (1989) A CAD System for Efficient Product Design Based on Design Intent. *CIRP Annals - Manufacturing Technology*, 38 (1), 149-152.
- [Lar12] LaRoca G. (2012) Knowledge based engineering: Between AI and CAD. Review of a language based technology to support engineering design. *Advanced Engineering Informatics* 26 (2012) 159–179. DOI: 10.1016/j.aei.2012.02.002.
- [Lar21] Larson E.J. *The Myth of Artificial Intelligence: Why Computers Can't Think the Way We Do*. The Belknap Press of Harvard University Press, 2021.
- [LaV07] LaViola J. (2007) Advances in Mathematical Sketching: Moving Toward the Paradigm's Full Potential, *IEEE Computer Graphics and Applications*, 27(1):38-48.
- [LDL19] Liu F., Deng X., Lai Y.-K., Liu Y.-J., Ma C., Wang H. (2019) SketchGAN: Joint sketch completion and recognition with generative adversarial network. *Proceedings of the IEEE Conference on Computer Vision and Pattern Recognition*, 5830—5839. DOI: 10.1109/CVPR.2019.00598.

- [LEM17] Livesu M., Ellero S., Martínez J., Lefebvre S., Attene M. (2017) From 3D Models to 3D Prints: an Overview of the Processing Pipeline. Eurographics 2017, Volume 36, Number 2, STAR – State of The Art Report.
- [LF92] Leclerc Y, Fischler M. (1992) An optimization-based approach to the interpretation of single line drawings as 3D wire frames. *Int. J. of Computer Vision*; 9(2): 113-136.
- [LF11] Lee Y.T., Fang F. (2011). 3D reconstruction of polyhedral objects from single parallel projections using cubic corner. *CAD Computer Aided Design*, 43(8), pp. 1025-1034.
- [LL10] Liu Y. and Lee Y.T. (2010) 3D reconstruction of freeform shapes from 2D line drawings VRCAI '10 Proceedings of the 9th ACM SIGGRAPH Conference on Virtual-Reality Continuum and its Applications in Industry
- [LLM10] Li M., Langbein F.C. and Martin R.R.(2010) Detecting design intent in approximate CAD models using symmetry. *Computer-Aided Design* 42 (3) 183-201
- [LLX20] Liu J., Lian Z., Xiao J. (2020) Sketch based modeling and editing via shape space exploration. *Multimedia Tools and Applications* (2020) 79:18121–18142. DOI: 10.1007/s11042-020-08677-0.
- [LS96] Lipson H, Shpitalni M. (1996) Optimization-based reconstruction of a 3D object from a single freehand line drawing. *Computer-Aided Design*; 28(8): 651-663
- [LSR18] Liu C., Rosales E., Sheffer A. (2018) Strokeaggregator: Consolidating raw sketches into artist-intended curve drawings, *ACM Trans. Graph.* 37 (4). DOI:10.1145/3197517.3201314
- [LT05] Liu J. and Tang X. (2005). Evolutionary Search for Faces from Line Drawings, *IEEE Transactions on Pattern Analysis and Machine Intelligence* 27(6), 861–872.
- [Mar91] Marill T. (1991) Emulating the human interpretation of line-drawings as three-dimensional objects. *Int. J. of Computer Vision*; 6(2): 147-161.
- [MAS18] Machuca, M.D.B., Asente, P., Stuerzlinger, W., Lu, J., Kim, B. (2018) Multiplanes. In *Proceedings of the Proceedings of the Symposium on Spatial User Interaction*; ACM: New York, NY, USA, pp. 36–47.
- [MLM01] Mills B.I., Langbein F.C., Marshall A.D., Martin R.R. (2001) Approximate symmetry detection for reverse engineering. *SMA '01: Proceedings of the sixth ACM symposium on Solid modeling and applications* May 2001 Pages 241–248. DOI: 10.1145/376957.376985.
- [MMO17] Martin, P., Masfrand, S., Okuya, Y., Bourdot, P. (2019) A VR-CAD data model for immersive design. In *Lecture Notes in Computer Science (including subseries Lecture Notes in Artificial Intelligence and Lecture Notes in Bioinformatics)*; 2017; Vol. 10324 LNCS, pp. 222–241.
- [MSA19] Machuca, M.D.B., Stuerzlinger, W., Asente, P. (2019) Smart3DGuides: Making unconstrained immersive 3D drawing more accurate. In *Proceedings of the 25th ACM Symposium on Virtual Reality Software and Technology*; ACM: New York, NY, USA, pp. 1–13.

- [MSG20] Mo H., Simo-Serra E., Gao C., Zou C., Wang R., (2020) General Virtual Sketching Framework for Vector Line Art ACM Transactions on Graphics, 40 (4), Article No.: 51, pp 1–14. DOI: 10.1145/3450626.3459833
- [MW80] Markowsky G. and Wesley M.A. (1980). Fleshing Out Wire Frames, IBM Journal of Research and Development, 24(5) 582–597.]
- [Neg75] Negroponte N. (1975) Sketching: A Computational Paradigm for Personalized Searching. JAE, Vol. 29, No. 2, pp. 26-29.
- [NG88] Nagendra I.V., Gujar U.G.(1988) 3-D objects from 2-D orthographic views - A survey. Computers & Graphics; 12(1): 111-114.
- [NOD21] Navarro, P., Orlando, J.I., Delrieux, C., Iarussi, E. (2021) SketchZooms: Deep Multi-view Descriptors for Matching Line Drawings. Computer Graphics Forum, 40(1), pp. 410-423.
- [OCC18] Otey J., Company P., Contero M. and Camba J.D. Revisiting the Design Intent Concept in the Context of Mechanical CAD Education. Computer-Aided Design and Applications (ISSN 1686-4360). 15(1), 47-60, 2018.
- [OK11] Orbay G., Kara L. B. (2011) Beautification of design sketches using trainable stroke clustering and curve fitting. IEEE Transactions on Visualization and Computer Graphics 17 (5), pp. 694-708. DOI: 10.1109/TVCG.2010.105.
- [OSC09] Olsen L., Samavati F.F., Costa Sousa M., Jorge J.A. (2009) Sketch-based modeling: A survey. Computers and Graphics 33 (1) 85-103
- [Pal99] Palmer S.E. *Vision Science, Photons to Phenomenology*, Cambridge, MA: The MIT Press, 1999
- [PBG21] Para W.R., Bhat S.F., Guerrero P., Kelly T., Mitra N., Guibas L., Wonka P. (2021) Generating Constrained CAD Sketches. In preparation. Cornell University, arXiv:2106.02711v1 [cs.LG] 4 Jun 2021.
- [PCV13] Plumed R., Company P., Varley P.A.C. (2013) Metrics of human perception of vanishing points in perspective sketches. *WSCG 2013, 21st WSCG Conference on Computer Graphics, Visualization and Computer Vision 2013*, WSCG 2013 Full Papers Proceedings (ISBN 978-80-86943-74-9), pp. 59-68.
- [PCV14] Plumed R., Company P., Varley P.A.C., Martin R.R. CSG Feature Trees from Engineering Sketches of Polyhedral Shapes. *Eurographics 2014, short papers (ISSN 1017-4656)*, pp 33-36. DOI: 10.2312/egsh.20141008
- [PCV16] Plumed R., Company P. and Varley P.A.C. Detecting mirror symmetry in single-view wireframe sketches of polyhedral shapes. *Computers & Graphics (ISSN 0097-8493)*. Vol. 59. October 2016. pp. 1-12. DOI: 10.1016/j.cag.2016.05.013
- [Per68] Perkins D.N. (1968) Cubic Corners, Quarterly Progress Report 89, 207-214, MIT Research Laboratory of Electronics
- [Per71] Perkins D.N. (1971) Cubic Corners, Oblique Views of Pictures, the Perception of Line Drawings of Simple Space Forms. *Geometry and the Perception of Pictures: Three Studies*. Harvard Project Zero. Technical Report No. 5.

- [PVC13] Plumed R., Varley P.A.C. and Company P. Features and Design Intent in Engineering Sketches, 3IA2012. Intelligent Computer Graphics 2012, Studies in Computational Intelligence, 2013, Volume 441/2013, 77-106. DOI: 10.1007/978-3-642-31745-3_5
- [PVC22] Plumed R., Varley P.A.C., Company P., Martin R.R. (2022) Extracting datums to reconstruct CSG models from 2D engineering sketches of polyhedral shapes. Computers & Graphics, 102, pp. 349–359, DOI: 10.1016/j.cag.2021.10.013.
- [RD21] Rizzuti S., De Napoli L., (2021) Interactive freehand sketching as the means for online communication of design intent in conceptual design conducted by Brainwriting. International Journal on Interactive Design and Manufacturing (IJIDeM), 15, pp. 143–149. <https://doi.org/10.1007/s12008-020-00745-x>.
- [Rob63] Roberts LG. *Machine perception of three-dimensional solids*. Ph.D. thesis, MIT Dep. of Electrical Engineering, 1963.
- [RSV89] Roller D., Schonek F., Verroust A. (1989) Dimension-driven Geometry in CAD : A Survey. In: Straßer W., Seidel HP. (eds) Theory and Practice of Geometric Modeling. Springer, Berlin, Heidelberg. DOI: 10.1007/978-3-642-61542-9_32.
- [RT05] Ros L., Thomas F. (2005) Geometric Methods for Shape Recovery from Line Drawings of Polyhedra. Journal of Mathematical Imaging and Vision, 22(1), pp. 5-18. DOI:10.1007/s10851-005-4779-4.
- [RV82] Requicha A.A.G., Voelcker H.B. (1982) Solid Modeling: A Historical Summary and Contemporary Assessment. IEEE Computer Graphics and Applications, 2(2), pp. 9–24.
- [RV83] Requicha A.A.G., Voelcker H.B. (1983) Solid Modeling: Current Status and Research Directions. IEEE Computer Graphics and Applications, 3(7), pp. 25–37.
- [RV85] Requicha, A.A.G., Voelcker H.B. (1985) Boolean Operations in Solid Modeling: Boundary Evaluation and Merging Algorithms. Proceedings of the IEEE, 73(1), pp. 30–44.
- [RW10] Roth-Koch S. and Westkaemper E. (2010) The implementation of a sketch-based virtual product development. Prod. Eng. Res. Devel. 4:175–183
- [SD08] Sezgin, T.M., Davis, R. (2008) Sketch recognition in interspersed drawings using time-based graphical models. Computers and Graphics 32 (5), pp. 500-510.
- [SGL09] Song H., Guimbretière F., Lipson H. (2009) The ModelCraft framework: Capturing freehand annotations and edits to facilitate the 3D model design process using a digital pen. ACM Transactions on Computer-Human Interaction. Article No. 14. DOI: 10.1145/1592440.1592443.
- [SIS17] Sasaki K., Iizuka S., Simo-Serra E., Ishikawa H. (2017) Joint Gap Detection and Inpainting of Line Drawings. 2017 IEEE Conference on Computer Vision and Pattern Recognition (CVPR), 2017, pp. 5768-5776, DOI: 10.1109/CVPR.2017.611.

- [SL96] Shpitalni M. and Lipson H. (1996). Identification of Faces in a 2D Line Drawing Projection of a Wireframe Object, *IEEE Transactions on Pattern Analysis and Machine Intelligence* 18(10), 1000–1012.
- [SOZ20] Seff A., Ovadia Y., Zhou W., Adams R.P. (2020) SketchGraphs: A Large-Scale Dataset for Modeling Relational Geometry in Computer-Aided Design. *arXiv:2007.08506v1 [cs.LG]* 16 Jul 2020. URL: <https://arxiv.org/abs/2007.08506>.
- [SSD01] Sezgin T.M., Stahovich T., Davis R. (2001) Sketch Based Interfaces: Early Processing for Sketch Understanding. *Proceeding SIGGRAPH '06 ACM SIGGRAPH*
- [ST97] Suwa M., Tversky B. (1997) What do architects and students perceive in their design sketches? A protocol analysis. *Design Studies*, 1997, 18(4), pp. 385–403.
- [Sug86] Kokichi Sugihara. *Machine Interpretation of Line Drawings*. The MIT Press, 1986. ISBN: 978-0262192545.
- [Suh07] Suh Y.S.(2007) Reconstructing 3D Feature-Based CAD Models By Recognizing Extrusions From A Single-View Drawing, *Proc. IDETC/CIE 2007*)
- [Sut63] Sutherland I.E. (1963) Sketchpad, a man-machine graphical communication system. Ph.D. thesis, M.I.T., Cambridge, MA USA.
- [SV89] Shapiro V., Voelcker H. (1989) On the Role of Geometry in Mechanical Design. *Research in Engineering Design*, vol. 1, pp. 69–73. DOI: 10.1007/BF01580004.
- [SZR21] Seff A., Zhou W., Richardson N., Adams R.P. (2021) Vitruvion: A Generative Model of Parametric CAD Sketches. In preparation. Cornell University, *arXiv:2109.14124v1*.
- [TAH20] Tanaka M., Asano T., Higashino, C. (2020) Isometric conversion of mechanical sketches into 3D models. *Computer-Aided Design and Applications*, 18(4), pp. 772-785. DOI: 10.14733/cadaps.2021.772-785.
- [TK14] Tanaka M., and Kaneeda T. (2014) A Method of Reconstructing 3D Models from Sketches by Extracting Features. *Journal of Advances in Information Technology*, 5(3), pp. 74-78 [TK14]. DOI:10.4304/jait.5.3.74-78.
- [TTA20] Tanaka M., Terano M., Asano T., Higashino C. (2020) Method to Automatically Convert Sketches of Mechanical Objects into 3D Models. *Computer-Aided Design and Applications*. 17(6), pp. 1168–1176. DOI: 10.14733/cadaps.2020.1168-1176.
- [TTH19] Tanaka M., Terano M., Higashino C., Asano T. and Takasugi K. (2019) A Learning Method for Reconstructing 3D Models from Sketches. *Computer-Aided Design & Applications*, 16(6), pp. 1158-1170. [TTH19]. DOI: 10.14733/cadaps.2019.1158-1170.
- [Ull02] Ullman D.G. (2002) Toward the ideal mechanical engineering design support system. *Research in Engineering Design*, 13(2): 55-64
- [UWC90] Ullman D., Wood S., Craig D. (1990) The Importance of Drawing in the Mechanical Design Process, *Computers and Graphics* 14(2):263-274

- [Var03] Varley P.A.C. Automatic Creation of Boundary-Representation Models from Single Line Drawings PhD Thesis, Department of Computer Science, Cardiff University, 2003.
- [VC10] Varley P.A.C. and Company P. (2010) A new algorithm for finding faces in wireframes. *Computer-Aided Design* 42 (4), 279-309
- [Vei11] Veigl, B. *Gestalt Teory* 33, p. 217, cited by Gestalt theory and Bauhaus – A Correspondence, between Roy Behrens, Brenda Danilowitz, William S. Huff, Lothar Spillmann, Gerhard Stemberger and Michael Wertheimer in the summer of 2011. *Gestalt Theory*, 34, No.1, p. 81-98. Introduction and Summary by G.J. Boudewijnse
- [VMS05] Varley P.A.C., Martin R.R. and SuzukiH. (2005) Frontal Geometry from Sketches of Engineering Objects: Is Line Labelling Necessary? *Computer Aided Design* 37(12), 1285-1307
- [Voe98] Voelcker H.B. (1998) The current state of affairs in dimensional tolerancing: 1997. *Integrated Manufacturing Systems*, 9(4), pp. 205–217.
- [VR15] Vinayak, Ramani, K. (2015). A gesture-free geometric approach for mid-air expression of design intent in 3D virtual pottery. *Computer-Aided Design*, 69, 11-24.
- [VR77] Voelcker H.B., Requicha A.A.G. (1977) Geometric Modeling of Mechanical Parts and Processes. *Computer*, 10(12), pp. 48–57.
- [WBD19] Jacqueline Wong, Martine Baars, Dan Davis, Tim Van Der Zee, Geert-Jan Houben & Fred Paas (2019) Supporting Self-Regulated Learning in Online Learning Environments and MOOCs: A Systematic Review. *International Journal of Human-Computer Interaction*, 35:4-5, 356-373, DOI: <https://doi.org/10.1080/10447318.2018.1543084>
- [WCL09] Wang Y., Chen Y., Liu J. and Tang X. (2009) 3D Reconstruction of Curved Objects from Single 2D Line Drawings *IEEE Conference on Computer Vision and Pattern Recognition CVPR 2009*, pp. 1834-1841.
- [WD99] Wenyin, L., Dori, D. (1999) From raster to vectors: Extracting visual information from line drawings. *Pattern Analysis and Applications*, 2(1), pp. 10–21.
- [WG93] Wang W., Grinstein G. (1993) A survey of 3D solid reconstruction from 2D projection line drawings. *Computer Graphics Forum*; 12(2): 137-158.
- [WJL21] Willis K.D.D., Jayaraman P.K. Lambourne J.G., Chu H., Pu Y. (2021) Engineering Sketch Generation for Computer-Aided Design. 2021 IEEE/CVF Conference on Computer Vision and Pattern Recognition Workshops. DOI: 10.1109/CVPRW53098.2021.00239.
- [WPL20] Willis K.D.D., Pu Y., Luo J., Chu H., Du T., Lambourne J.G., Solar-Lezama A., Matusik W. (2020) Fusion 360 Gallery: a Dataset and Environment for Programmatic CAD Reconstruction. Cornell University. arXiv:2010.02392.
- [WYI20] Watanabe T., Yoshikawa T., Ito T., Miwa Y., Shibata T., Saga S. (2020) An infinite-resolution grid snapping technique based on fuzzy theory, *Applied Soft Computing*, 89, 106112. DOI: 10.1016/j.asoc.2020.106112.

- [YTJ08] Yuan S., Tsui L.Y., Jie S. (2008). Regularity selection for effective 3D objects reconstruction from a single line drawing. *Pattern Recognition Letters* 29 (10), 1486-1495.
- [YVG20] Yan C., Vanderhaeghe D., Gingold Y. (2020) A benchmark for rough sketch cleanup. *ACM Transactions on Graphics*, 39(6),163
- [XCS14] Xu B., Chang W., Sheffer A., Bousseau A., McCrae J., Singh K. (2014) True2Form: 3D curve networks from 2D sketches via selective regularization. *ACM Transactions on Graphics*, 33(4). Article No.: 131, pp 1–13. DOI: 10.1145/2601097.2601128.
- [XL10] Xiong, Y. and LaViola J. (2010) A ShortStraw-Based Algorithm for Corner Finding in Sketch-Based Interfaces, *Computers and Graphics*, 34(5):513-527.
- [XSC08] Xin M., Sharlin E., Costa-Sousa M. (2008) Napkin Sketch - Handheld Mixed Reality 3D Sketching. *VRST '08: Proceedings of the 2008 ACM symposium on Virtual reality software and technology*, pp. 223–226. <https://doi.org/10.1145/1450579.1450627>
- [XWR09] Xuetao Y., Wonka, P., Razdan, A. (2009) Generating 3D Building Models from Architectural Drawings: A Survey . *IEEE Computer Graphics and Applications*, 29 (1), 20-30.
- [ZDY19] Zeng L., Dong Z. K., Yu J. Y., Hong J., Wang H. Y. (2019) Sketch-based Retrieval and Instantiation of Parametric Parts. *Computer-Aided Design*, 113, pp. 82-95.
- [ZGZ20] Zhong Y., Gryaditskaya Y., Zhang H., Song Y.Z. (2020) Deep Sketch-Based Modeling: Tips and Tricks. *Proceedings - 2020 International Conference on 3D Vision, 3DV 2020*. 9320101, pp. 543-552.
- [ZLW14] Zeng L., Liu J., Wang J., Zhang D. L., Yuen M. M. F. (2014) Sketch2Jewelry: Semantic feature modeling for sketch-based jewelry design. *Computers &Graphics*, 38, pp. 69-77.