

Audiovisual Technology. Broadcasting and Digital Media

Francisco J. López Cantos

Col·lecció «Sapientia», núm. 133

AUDIOVISUAL TECHNOLOGY. BROADCASTING AND DIGITAL MEDIA

Francisco J. López Cantos

■ Codi d'assignatura CA0931

UJI UNIVERSITAT
JAUME I

Edita: Publicacions de la Universitat Jaume I. Servei de Comunicació i Publicacions
Campus del Riu Sec. Edifici Rectorat i Serveis Centrals. 12071 Castelló de la Plana
<http://www.tenda.uji.es> e-mail: publicacions@uji.es

Traducció: Mónica Martínez-Falero
Correcció: Birgit Weiss

Col·lecció Sapientia 133
www.sapientia.uji.es
Primera edició, 2018

ISBN: 978-84-16546-93-0
DOI: <http://dx.doi.org/10.6035/Sapientia133>



Publicacions de la Universitat Jaume I és una editorial membre de l'UNE, cosa que en garanteix la difusió de les obres en els àmbits nacional i internacional.
www.une.es



Reconeixement-CompartirIgual
CC BY-SA

Aquest text està subjecte a una llicència Reconeixement-CompartirIgual de Creative Commons, que permet copiar, distribuir i comunicar públicament l'obra sempre que s'especifique l'autoria i el nom de la publicació fins i tot amb objectius comercials i també permet crear obres derivades, sempre que siguin distribuïdes amb aquesta mateixa llicència.
<http://creativecommons.org/licenses/by-sa/3.0/legalcode>

Aquest llibre, de contingut científic, ha estat avaluat per persones expertes externes a la Universitat Jaume I, mitjançant el mètode denominat revisió per iguals, doble cec.

CONTENTS

Coberta

Portada

Crédits

1. History of Audiovisual Technologies

- 1.1. Motion Picture Technology
- 1.2. The Electronic Image. The Beginnings of Television

2. The Digital Video Signal

- 2.1. Digital Image Capture
- 2.2. Audiovisual Coding and Compression
- 2.3. Storage Media Systems

3. Digital Production Systems

- 3.1. Audiovisual Production Systems and Formats.
- 3.2. Audiovisual Post-production
- 3.3. TV Production Studio

4. Audiovisual Content Distribution Systems

- 4.1. Digital Cinema Distribution. The DCI system
- 4.2. Digital Television Systems. Transmission Standards
- 4.3. Communication Networks. Internet TV
- 4.4. Television Monitoring and Digital Cinema Projection

Bibliography

- Basic Bibliography
- Complementary Bibliography

1. History of Audiovisual Technologies

Summary

In the first section of this textbook, we will make a historical tour of the different technologies that have been used for the capture of moving images since the beginning of cinematography, as well as the systems of transmission of distance images developed throughout the twentieth century, with the aim of contextualizing and evaluating the current technologies of video and television.

First, we study the evolution of technologies based on cinematographic media and then examine in detail the characteristics of the electronic technologies which underpin video and television systems. Finally, we analyze digital video systems and new digital transmission technologies.

1.1. Motion Picture Technology

Throughout the first decades of the nineteenth century, and in a context of accelerated industrialization and consolidation of the hitherto emerging bourgeois class in the midst of dynamic and thriving cities, apparatuses and inventions started to be developed, a kind of mixture between experimental sciences and simple fairground attractions, which were more or less successful. They were the result of the new technological possibilities offered by constant improvements in mechanical engineering and research on human perception, and were implemented in an era of intense development of scenic technologies. These new technologies delighted the growing audiences, which started flocking to these new spectacles in the advent of cinematography.

The persistence of vision was demonstrated by William Herschel, an eminent astronomer who had promoted important advances in optics, around the 1820s, as a result of a bet he won by showing that it was possible for a shilling to be seen at the same time by his obverse and by its reverse, its two faces. To prove this, he used a rope tied to each of the ends that tensed again and again to rotate the shilling on its axis, thus giving rise to the visual overlap of both sides of the coin, and thus showing that it was possible to see both at the same time. Thereby he laid the experimental basis for the perceptual phenomenon called *phi effect*, formulated by Max Wertheimer in 1912, and some years later, in 1916, complemented by Hugo Münsterberg, postulating that the persistence of vision produced this psychological effect of the perceptual continuity of the movement when successive images were shown with a sufficient cadence.

Although it took some time to come up with a formal definition of the *phi phenomenon*, apparatuses that took advantage of retinal persistence began to proliferate and to be exhibited in all kinds of public events, amazing the attendees and creating successful scientists who performed spectacular demonstrations of perceptual illusions. One of these early inventions based on Herschel's wit was called *thaumatrope*, an artifact developed by John Paris with a two-sided surface alternating an empty cage with a parrot. The effect was that the parrot got locked in the cage when spinning the toy.

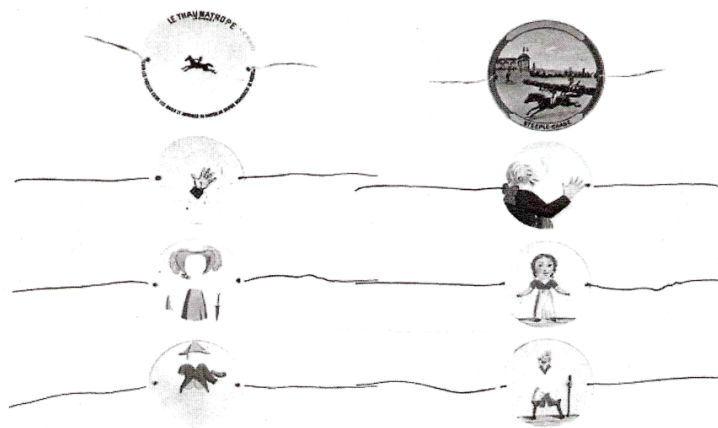

Figure 1. Thaumatrope - Paris (Martínez Badía and Serra 2000)

Shortly after, around 1829, Plateau invented the *phenakistiscope*, another toy that in that case consisted of an interchangeable disc of 16 vignettes which was observed in front of a mirror through slits that coincided with the vignettes and which allowed to see them with a rhythm of 16 images per second, optimal to observe the movement with fluency. Below 12 the intermittent darkness became visible, and for that reason the number of 16 was chosen.



Figure 2. Phenakistiscope - Plateau (Martínez Badía and Serra 2000)

Since 1834, various versions of these stroboscopic toys, that is to say toys which alternated light and dark, began to be developed, giving them various more or less ingenious denominations, such as the *zootrope* of William G. Horner, that used a circular drum in place of a smooth plate facing a mirror. Also at that time, these toys were combined with the magic lantern, which was nothing more than a slide projector with built-in light, thus obtaining interesting scenic effects, as in the public projections offered by Baron Franz von Uchatius who placed several projectors aligned with slides in different phases of the movement, and passed a torch lit successively by each of them, thus obtaining an illusion of movement very credible for the astonished spectators. Thereafter, the development of sophisticated projection techniques began, such as the one scenographer Joseph Reynaud would show decades later for projecting a spectacular *Pauvre Pierrot* in 1891 with his *praxinoscope*, with which he delighted the public at the end of the 19th century, and laid the foundations of contemporary spectacle, although today with more advanced technologies.

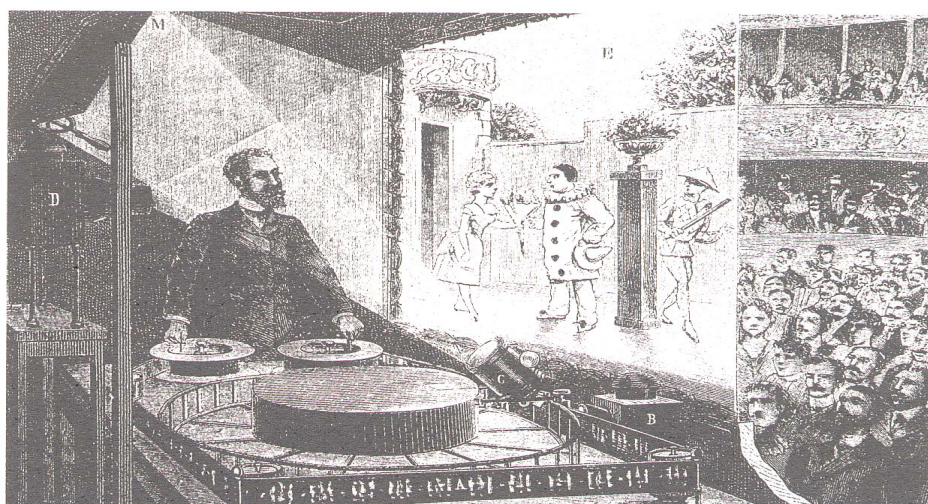

Figure 3. Praxinoscope - Reynaud (Martínez Badía and Serra 2000)

In those decades, the knowledge and technologies that laid the foundations for the creation of the film industry began to converge, increasing the interest of the public by the mass shows that used the new findings and inventions developed around the decay of the movement.

The immediate antecedent of the cinematograph is attributed to the inventiveness of Eadweard Muybridge, an English half-tramp and half-photographer who walked through California and, spurred by necessity, ended up getting hired by the state governor who needed his help to win a \$ 25,000 bet he had with a friend. The challenge was to determine if, during its gallop, a horse had - or had not - its four legs in the air at the same. It was the year 1877, and to demonstrate that the governor was right, Muybridge installed a system of 24 cameras in a row that were operated at the pace of the horse with a cable release. The following year, it was finally possible to show the invention and everybody could see the

mare Sally simultaneously put her 4 legs in the air. The ingenious moving image capture system of Muybridge cost no less than \$ 40,000, but it served the governor to earn his \$ 25,000.

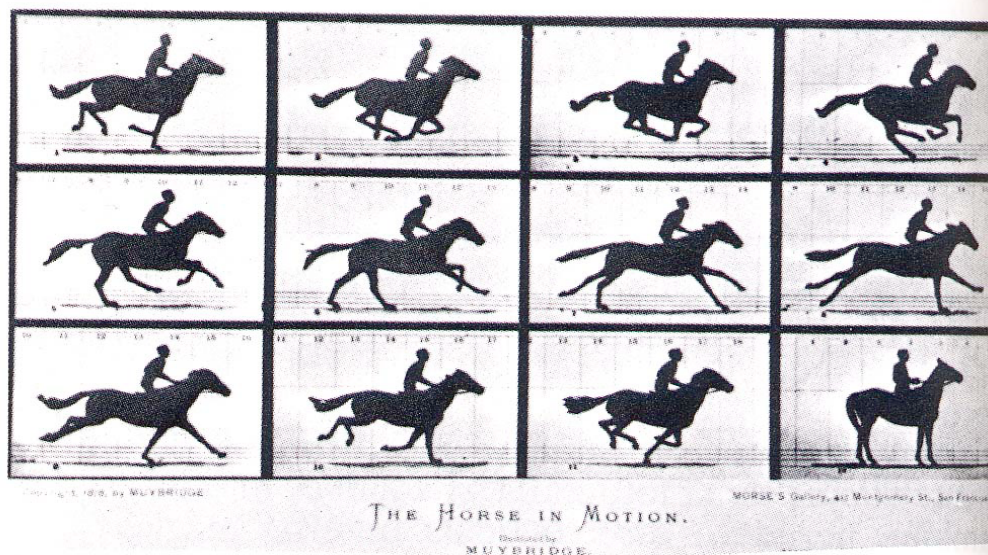
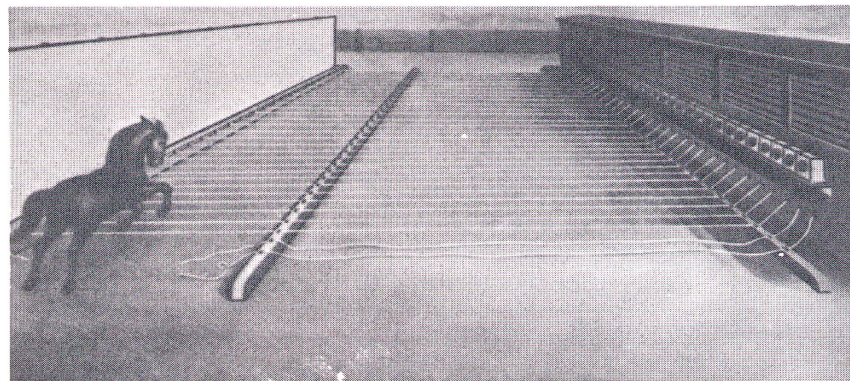

Figure 4. Sally Gardner at a Gallop, 1878 - Muybridge (Mappe 1993)

Muybridge later perfected his technique by mounting 48 cameras and once, capturing the images by placing the photographs on a circular phenakistiscope that he combined with a magic lantern, which allowed him to make public projections of his moving photographs, baptizing his artifact with the name of *zoopraxiscope*. Shortly after, he traveled to Paris to meet Jules Marey, who since 1882 had already obtained moving images by using a single camera as a photographic rifle. Around 1888, Marey replaced the photographic plates by paper film, in what he called *chronophotographs*, thus obtaining automatically the capture of the movement and giving an unprecedented impulse for the development of the cinematographic technology, parallel to Muybridge.

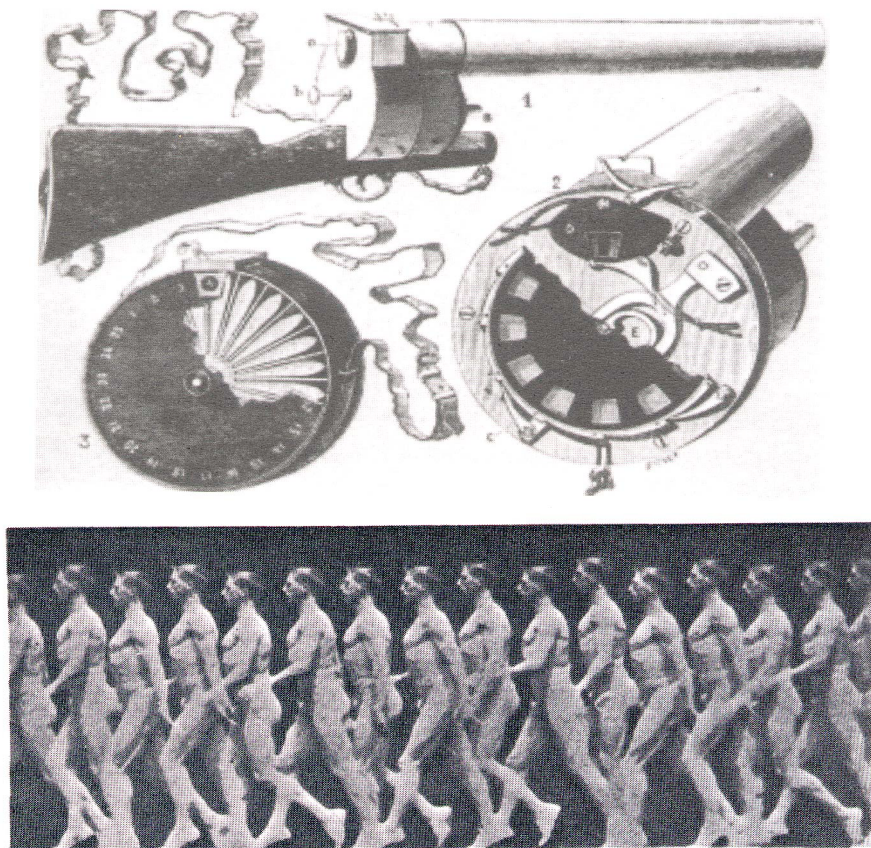

Figure 5. Photographic rifle and chronophotography - Marey (Martínez Badía and Serra 2000)

To achieve their purposes, Marey had taken advantage of the invaluable advancement of photography by replacing the then-shaky and fragile photographic plates with the new rolls of photographic paper that George Eastman-Kodak began to market in 1884. Shortly after, around 1889, Kodak would put on the market, the film on celluloid that ended up being the support on which the whole film industry has been developing since then and, a year later, began to sell to the public the first automatic photographic camera of the world, the Kodak nº 1. This was the beginning of a new century, the twentieth century, which was characterized by the extraordinary popularization of the technologies of the image and the important development of the audiovisual industry and entertainment. The audiovisual industry had already been developed since the invention of printing and photography, but it would gain an unusual impulse and spread vertiginously to dig deep into society and contemporary culture since the invention of cinematography.

Like Marey, Thomas Alva Edison, an prominent inventor who had made a fortune with the commercialization of patents for the emerging electrical and telecommunication industry from which he had become a tycoon in a few years, invited Muybridge to his laboratories and even gave him space in his factory to work with sufficient resources and adequate funding. Muybridge was commissioned to develop the system invented by Edison himself to record sounds, the *phonograph*,

hoping that he would create from it a system of recording photographs on a wax cylinder that would be able to reproduce synchronized images and sounds. However, the Muybridge-Edison association was unsuccessful and the synchronization of image and sound was not possible until the late 1920s, although it was never stopped trying since the beginning of the century, while continuing to develop separately the technologies of capture, recording and projection of moving image and technologies of production and sound diffusion.

The invention of the cinematograph came from another of the employees of Edison, its project director, Dickson, who in 1889 invented a system of capture of images that he called *kinetophonograph*, that later Edison patented as his property, calling it *kinetoscope*. The first film recorded with this system, *Record of a Sneeze*, seems to have been shoot in 1893 or 1894, and there is no evidence that a sound synchronization system has been achieved, and only the recorded film is preserved with the images on a celluloid strip. Although the system worked, the quality of the projection was very poor, and therefore –and also for purely commercial reasons–, Edison separated the invention into two patents, the *kinetograph* for the recording and the *kinetoscope* for the projection, and he began to commercialize both cinematographic equipment individually. The kinetoscope was installed in separate and private viewing machines that were distributed in a row and operated by introducing a fivepence coin –a nickel–, a term that would later give place to *nickelodeon*, as would be called the large rooms, the *odeons*, which were used for film screening.

Edison's fivepence machine worked by placing an endless film in the kinetoscope, that is, with the beginning and the end united, which passed once per coin, although the imprecision of the system did not guarantee that the beginning of the viewing coincided always with the the beginning of the film, which was unassembled and had a duration of about 20 seconds with a frequency of 40 to 46 frames, the recording speed the kinetographers worked with. The great success of Edison's invention provoked a feverish activity in his factory, whose cinematographic production was still under the direction of Dickson, and thus, in 1893, the creation of the first cinematographic study of the world, the *Black Maria*, in order to increase productivity and improve the lighting conditions, which were then quite terrible because of the still slow technological development in lighting technology and the low sensitivity of the photochemical supports used for the cinematographic recording.

Edison is also credited with the massive introduction of film perforation as proposed by Kodak, and thus began to refine their projectors, although the intensity of available lighting was insufficient for large audiences and the dragging problems of the film caused it to break easily, so that the projections were often deficient. Later Edison also purchased the patent that the Lantham brothers had developed with the design of a special clip to keep the film on their guides that avoided breaks or displacements in the frames during the screening, and adapted it to a new equipment that he called a *vitascope*. This new equipment, although it still had some problems of instability during the projection and was even dangerous given the

ease of combustion of the nitrates contained in the cinematographic film of that time, was finally installed everywhere and, since 1905, the regular use of large spaces for spectacular screening started, the aforementioned *nickelodeons*, heirs of those five-pence machines for individual viewing.

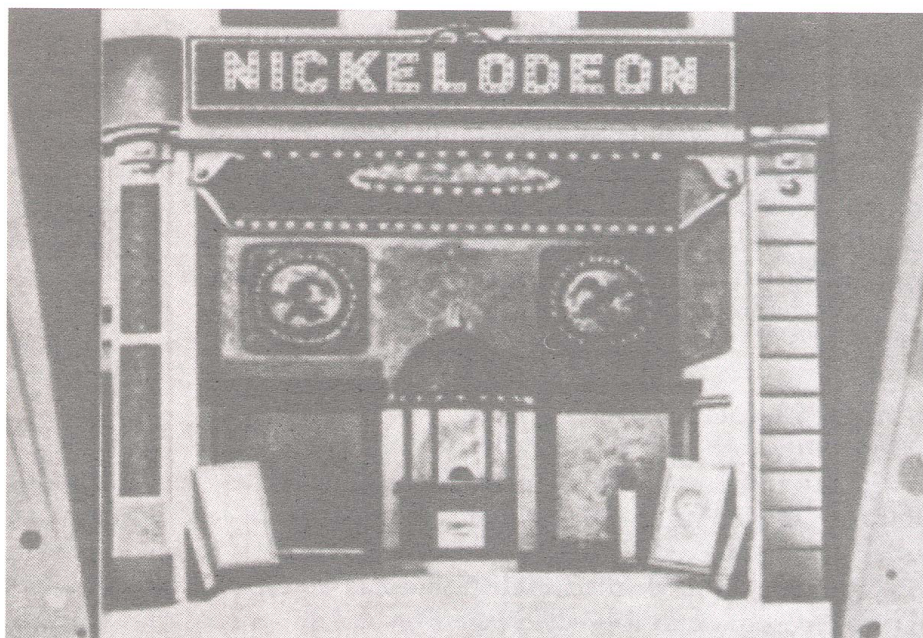
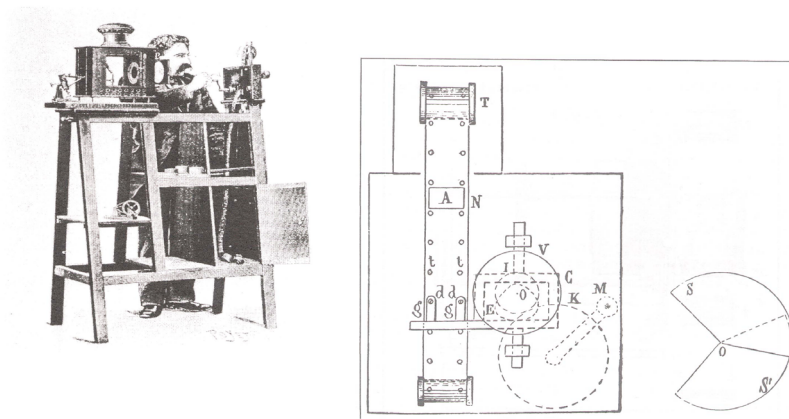

Figure 6. Nickelodeon - Edison (Martínez Badía and Serra 2000)

However, on the other side of the Atlantic, in France, other inventors were also working on the development of technologies for obtaining moving images, and Marey was followed by the Lumière brothers, who since 1894 had begun to work with Edison's *kinetographer* and *kinetoscope*, as a result of the development that was taking place in the factory of photographic plates that their father directed who began to produce film in the form of celluloid. Soon they created their own system, in 1895, and called it *cinematograph*, which had the peculiarity that it worked with a perforated film of 35mm and at a rate of 16 frames per second intermittently projected using a shutter. Unlike the electrical and heavy equipment that commercialized Edison, the cinematograph was much more manageable because it was portable and manual. The public presentation of the Lumière's cinematograph took place on December 28, 1896, at the Grand Café in Paris, and this date is considered the first film screening in a room with an audience in history, well before the first projections in the nickelodeon.



CINÉMATOGRAPHE

LUMIÈRE

Véritable Maison LUMIÈRE
CRÉÉE EN 1896

GRAND CAFÉ

14, Boulevard des Capucines, 14

Entrée: 1 fr.

La situation de la Salle, l'installation des appareils pour l'exécution parfaite des projections animées, éclairées par l'eau et l'électricité (*nouvelle invention remplaçant la lentille*), le choix et le nombre variés des vues, rendent ce spectacle incomparable.

Séances de 2 h. à 6 h. et de 8 h. 1/2 à 11 h.

Ne pas confondre avec les Établissements similaires
qui n'ont pas été créés par la
MAISON LUMIÈRE

Tous les Samedis, changement du programme à 8 h. 1/2 du soir.

PROGRAMME

12 TABLEAUX

dont plusieurs sont d'une durée de 10 à 15 minutes

CORTÈGES, DÉFILÉS MILITAIRES, DANSES,
VUES COMIQUES, ETC.

Les Familles peuvent assister aux Séances dont la moralité est assurée
SÉANCES EN VILLE & EN PROVINCE

Le Cinématographe peut fonctionner dans les Salons

Piano de la Maison GAVEAU

Tenu par M. Emile MARAVAL, Pianiste-Compositeur.

Figure 7. Lumière's Cinematograph (Mappe, 1993)

As a result of the strength of the new industry and the new technological developments on each side of the Atlantic, there was a strong competition between Lumière and Edison as well as other new companies, such as Gaumont and Pathe, and the American companies *Biograph*, owned by Dickson, and *Vitagraph*, owned by John Stuart Blackton, who in 1906 already began to produce the first animated films. And, as part of this strategy of industrial establishment, the more or less fortunate attempts to synchronize image and sound, although with little success, continued over the following decades.

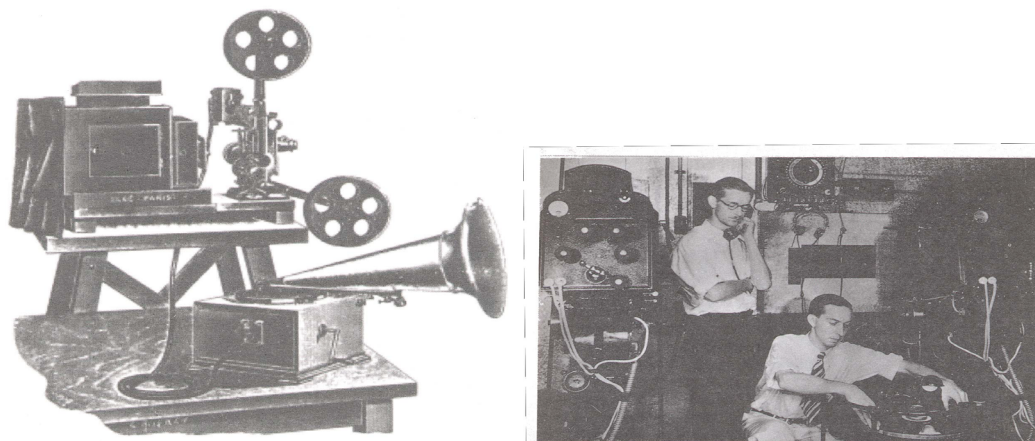
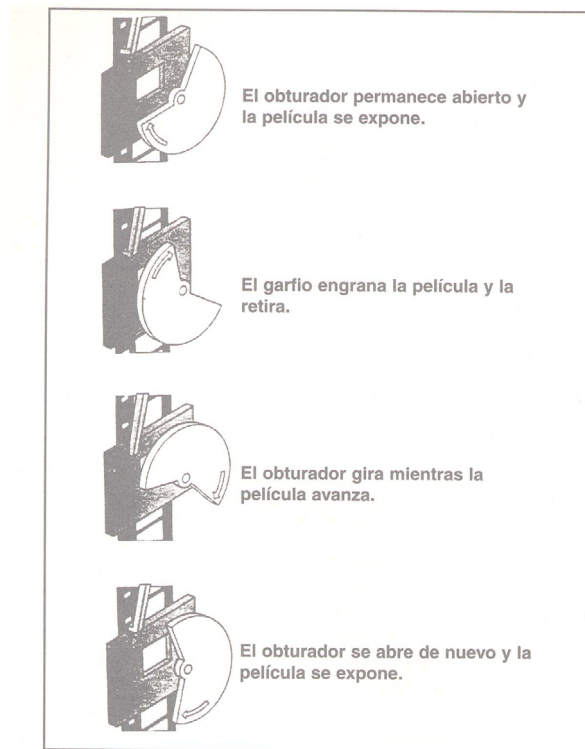

Figure 8. Synchronic Sound System Elgephone-Gaumont and Vitaphone-Edison (Martínez Badía and Serra 2000)

In any case, at the beginning of the twentieth century the audiovisual industry had already begun its unstoppable expansion and global social and economic establishment, and since then the mechanical engineering and the precision of the cinematographic equipment would continue to develop enormously. To commercialize various formats, systems and photochemical supports gave a wide range of possibilities to motion-pictures technology that would mature during the first decades of the twentieth century and dominate the entertainment industry until very recently.

Below we can see the operation of the shutter at the film register and an example of the optical system adopted to record the modulated sound on the side of the film as well as the various film formats most commonly used.



FORMATO	DIMENSIONES Alto x Ancho (mm)	
TODOS	18,66 x 24,89	35 mm ventanilla abierta, <i>Full Aperture</i> o <i>Silent Aperture</i>
1,37:1	16,02 x 22,05	35 mm de la Academia
1,85:1	11,33 x 20,95	35 mm ventanilla de 1,85:1
1,33:1	13,60 x 24,11	35 mm para televisión (zona de seguridad recomendada por SMPTE)
2,35:1 o 2,40:1	18,67 x 22,05	35 mm anamórfico con compresión 2X horizontal
2,40:1	10,01 x 24,00	Panavision 35 mm para comprimir 2X en positivadora óptica y proyectar desanamorizando
1,85:1	12,98 x 24,00	Super 35 Panavision para comprimir en positivadora óptica y proyectar desanamorizando
1,33:1 o 1,85:1	13,87 x 24,89	Ventanilla abierta para tres perforaciones por fotograma



Figure 9. Shutter, formats and sound in cinematography (Martínez Badía and Serra 2000)

At the base of the development of the film industry are the photochemical supports for image registration, descendants of photography that have evolved along decades in terms of sensitivity and ease of use, from the first emulsions that were only blue sensitive to later orthochromatic films, and since the 1930s, with the appearance of the *Technicolor* system and the commercialization of films, the color registration in three or more sensitive layers. There were earlier attempts for color registration, such as the *Dufaycolor* system that used albumin microspheres as a filter mosaic on a monochromatic emulsion, or the *Pathecolor* system, among others, in which a dye primer was made on three emulsions in which an image of each of the primary colors had been formed, and then put in register for the projection.

With the invention of Technicolor, the results in the copies were more stable and the quality and the saturation of the color in relation to the techniques used by the Pathé system improved. This color system ended up consolidating the cinematographic technology, reaching a level of technical sophistication that, although it would still be improved in the following decades, already made it possible to use technological resources without limitations and to explore its expressive possibilities to their full extent.

At present, cinematographic technology is still producing in both black and white and color, yet no longer as a technological or economic imposition but for its expressive value, based on supports and processes of photochemical registration, although it is quickly becoming outdated against the implantation of digital technology as it is requiring, as we see below, complex and costly processes.

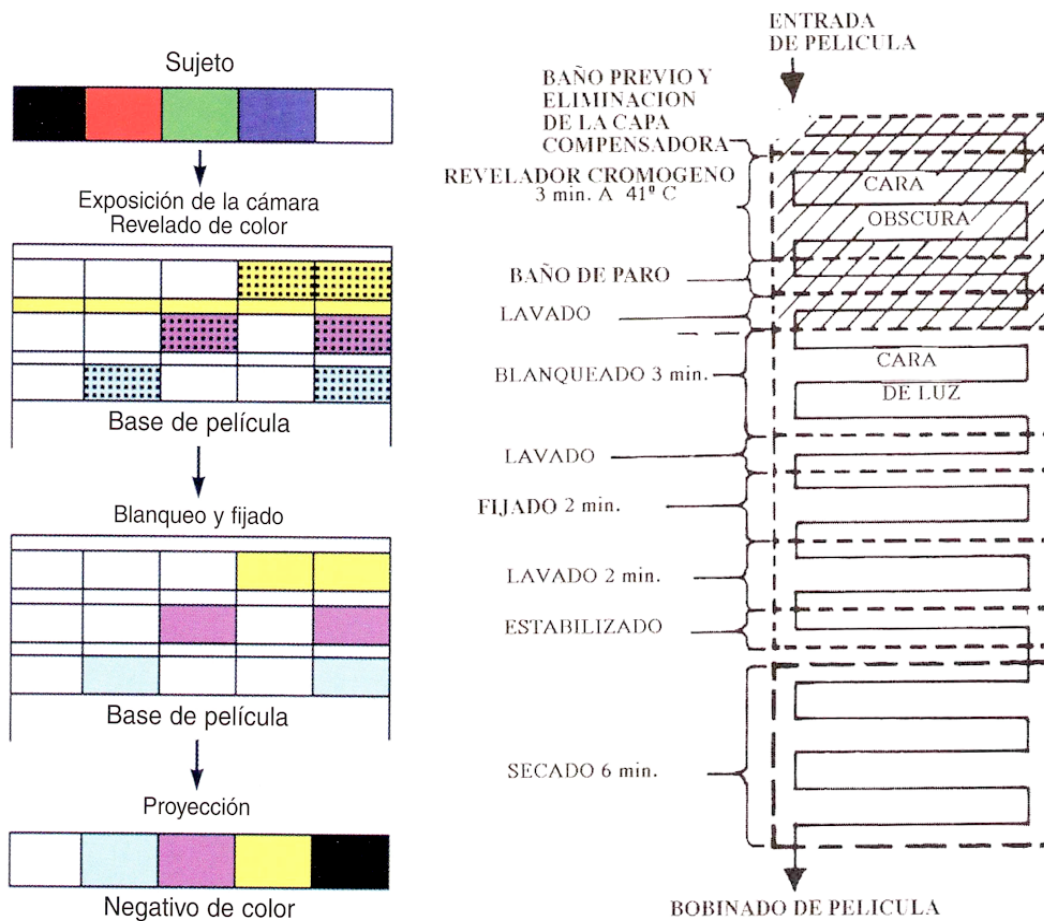
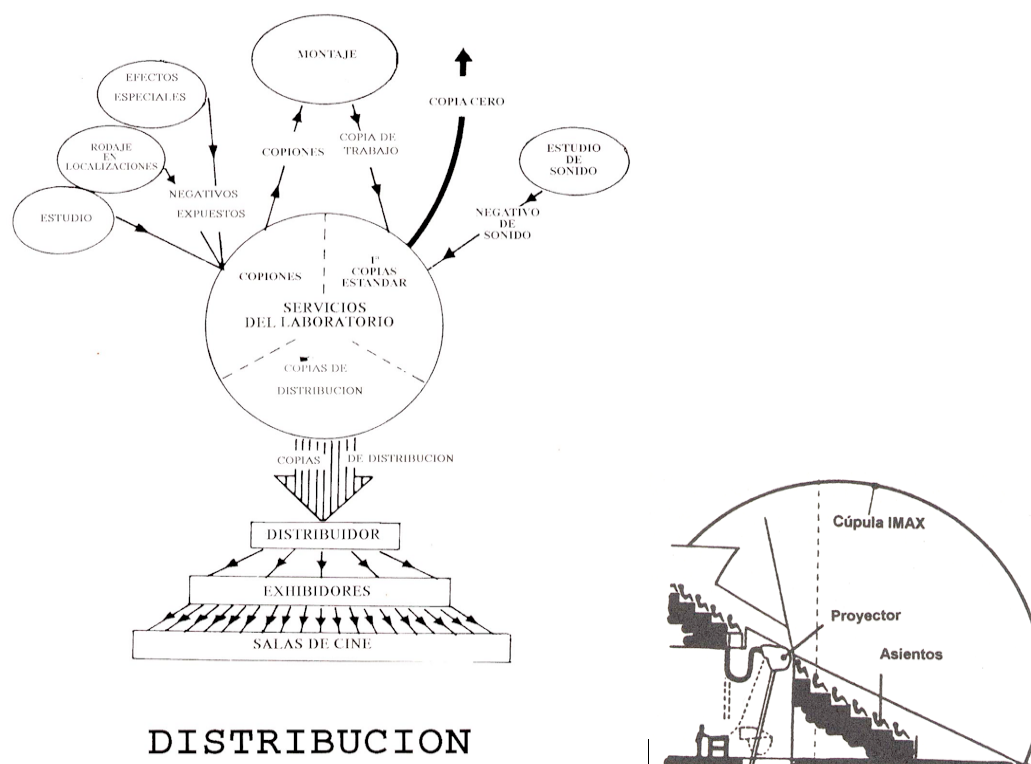

Figure 10. Photochemical System (Langford 1996)

All that laid the ground for the development of a system of cinematographic production and distribution that has been improving throughout the last century with strong industrial implementation and that is now perfectly consolidated, as we see in the scheme below.

PRODUCCION



DISTRIBUCION

Figure 11. Analog Film Production System and Omnimax Projection (Mappe 1993)

However, the technologies and models of traditional film production are already obsolete in the face of the profound changes brought about by the emergence of digital technology. New strategies are developing to increase the spectacularity of audiovisual projection in an effort to survive the enormous competition between various technologies, such as the one that already occurred in the decade of the '50s of the last century with the implementation of television, and today against new digital multimedia platforms of audiovisual distribution.

1.2. The Electronic Image. The Beginnings of Television

Throughout the twentieth century, and concurrently with the transformations that occurred in political and socioeconomic models as a result of industrialization and new ideological trends, cultural industries developed globally. The current multimedia communication networks are the result of decades of technological and industrial development in which the entertainment industries are constituent elements of our contemporaneity, first driven by the recording and cinematographic industry and, shortly after, by the vertiginous development of the radio systems and, after the post-war period, the television systems. As already explained in the previous part, the systems of registration of images by photochemical means were

consolidating throughout the first decades of the century at the same time as the technologies based on the great new discovery of the epoch, the electricity, well-known and well-profitable for some magnates of the communication of the time like Edison, as already mentioned before, began to develop and to extend.

The extension of telegraph and telephone networks began to take shape in the last decades of the nineteenth century, until it formed a network of global telecommunications that has reached the present day, and which caused not a few clashes and political and economic battles in the traditional power blocks that dominated the territory based on the colonial settlements which had been established in previous centuries (for further details the didactic material of the subject of Communication Technology can be consulted).

In this context, and very early on, a series of discoveries and experiments with electronic technology that were made a few decades later would result, toward the end of the 1930s, in the implantation of the use of television systems at home and, some years later, of the video recording technologies.

As early as in the 1860s, some researchers, e.g. May and Smith, began to investigate and experiment with elements and chemical compounds such as selenium whose properties varied when coming into contact with light, but not in the same way as with those already used such as silver halide for photochemical registration in which oxidation processes were produced with the consequent blackening of the silver. Selenium, on the other hand, was able to transduce the light energy into electric power depending on the intensity received. Other elements with which there were experiments a little later, such as cadmium or cesium, also varied their properties when exposed to light, in these cases varying their resistance to the passage of electric current in a manner equally proportional to the light intensity received.

May and Smith publicly presented their discoveries in 1873 and not much later, in 1875, they began to design the first matrix plates based on selenium cells. The first of the matrix systems of selenium sensors that allowed to elaborate images and to see at a distance by the use of the electricity –that later would receive the name of *television*– was constructed by Carey, connecting two plates in parallel and cell-to-cell to transmit images from one to the other by means of the wire that connected them. A year later, in 1876, Alexander Graham Bell made possible the telephonic transmission of complex images using materials that transduced light in electricity in a similar way and could record images that were encoded in the transmitter and decoded in the receiver, thereby making telecommunication possible .

The problem that was then –and is still today, despite the enormous advances in research of conductive materials– the one related to the limitations of the transmission channel, that is to the bandwidth as we call it in contemporary terms. The scarce amount of information that was possible to transmit then greatly limited the development and effective implementation of image transmission systems that would allow a minimum quality. The first systems, moreover, operated in parallel

which multiplied costs extremely and could only be experienced in laboratory research supported by very solvent financial partners because these technologies were very impractical and commercially unviable.

The solution that was found for the problem of transmission and the high cost of developing the equipment was provided by Senlecq, who in 1878 designed a system of matrix plates with sequential scanning. Thus, the resulting electric intensity of each selenium photoreceptor cell was transmitted in an orderly manner in a continuous electronic flow in which each reading occurred, and thus used a single transmission channel for all of them, a single wire. The complexity and limitations of the Senelecq system were, of course, the frequency of readings the system was able to perform in a given time period, i.e. the amount of information per second it was able to transmit. Nevertheless, and although the system was very rudimentary, it had been possible to converge the form of transmission by means of conventional telephone lines with the systems of electrical record of images, laying the bases for the impulse of the multimedia telecommunications that arrive until our days, with technologies such as Internet and ADSL, advanced contemporary technological developments whose foundations, bridging the gap, are not far from those pioneering transmission systems.

The Senlecq system was not very effective when put in practice with the technology at its time, and only from 1884 on, a viable system of vision of remote images, that is to say television, began to be developed, including a mechanical-electric equipment powered by Nipkow. The system was designed from a sequential reading system on two identical and synchronized discs, one in the register and the other in the projection, in which 24 equispaced holes were formed, forming a spiral that rotated at 600 revolutions per minute. No prototype could be built, but the Nipkow-designed system laid the foundations to develop television and –a few years later in Britain, as we will see later– would allow the construction of television receivers that started to be commercialized when technology was sufficiently developed for this purpose.

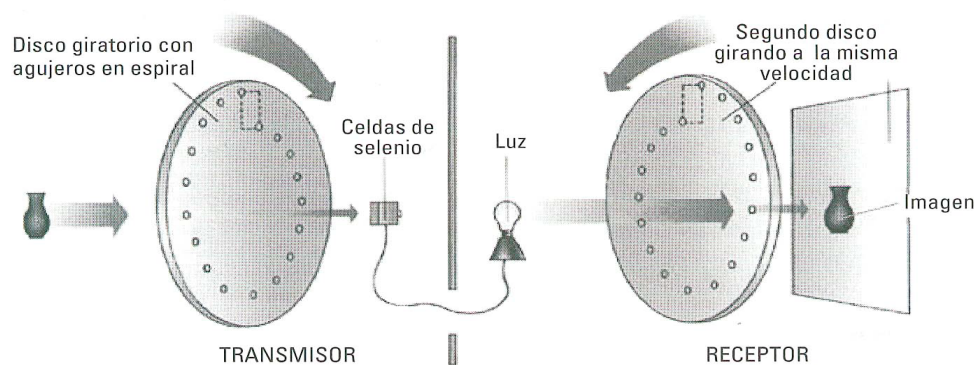

Figure 12. The Nipkow's System (Pérez and Zamanillo 2003)

Once the theoretical bases of the mechanical-electrical systems of transmission of images were set, important engineering advances started on both sides of the Atlantic that definitively inspired the development of the technology of the television and the transmission by electromagnetic waves, mainly starting in the 1920s, once the first major world race ended.

Starting in 1922 in the United States, and with the help of C. F. Jenkins, systems for the reproduction of images using electric methods were developed and perfected, and in 1925 images using radio networks were transmitted for the first time. It was possible to establish a transmission between Washington and Philadelphia, and RCA (Radio Corporation of America, one of the most important radio networks of the country at that time) purchased the patents to commercialize the system. Also H.C. Ives successfully conducted experimental tests in 1925 to transmit still images in color using telephone networks, and thanks to his association with Bell Telephone and ATT, the country's two largest telephone companies, transmitted high-quality color pictures between Washington and New York in 1927, thus promoting the technological development of telecommunications infrastructures for the exchange of journalistic information, which until then allowed only the transmission of textual information.

On the other side of the Atlantic, in Europe, advances were also occurring in the technologies of telecommunication of images and, likewise in 1925, John L. Baird experimented with the transmission of images at distance through the cable networks and shortly after, in 1927, he successfully completed a telephone transmission between London and Glasgow. The following year, he managed to broadcast color television and a couple of years later, he achieved a transmission in which the image was synchronized with the sound, technological successes that may give an idea of the speed with which the innovations happened and accelerated the development of the audiovisual technologies and the significant changes that were to take place thereafter.

The impulse and implantation of the television in Europe was propitiated by the British BBC (similar radio chain in terms of technology, implantation and industrial solidity to the RCA of the USA but located in Great Britain), who managed to realize the first transmission-reception of images on this side of the Atlantic in 1929, using a mechanical-electrical system similar to Nipkow that reached a horizontal resolution of thirty lines. The first industrial tests of television-receiver construction were a success, and they began to commercialize faster having an immediate acceptance by the public, reaching in 1932 sales that surpassed the 10,000 receivers with the disk system of Nipkow and thirty lines of resolution. Soon the market would become very competitive and a few years later the American company Marconi, in association with EMI, developed a commercial system of 405 lines and totally electric, using the *iconoscope* that was previously developed by V. K. Zorwykin at the Technological Institute of Saint Petersburg in 1907.

Fully electronic television systems based on cathode ray tubes (CRTs) such as the iconoscope had already been described for the first time by Campbell and Swinton

in the magazine *Nature* in 1908, based on the CRT prototypes developed by KF Braun in Strasbourg in 1897. Aware of such developments and with the design of the iconoscope, Zworykin emigrated to the US and began working for Westinghouse and RCA, obtaining results very soon in 1923, the same year in which the first television receiver was designed. It worked with cathode rays, based on a cathode for the generation of a flow of electrons that were directed by electrostatic and electromagnetic deflection for the exploration of the image that was captured in an electrically charged mosaic.

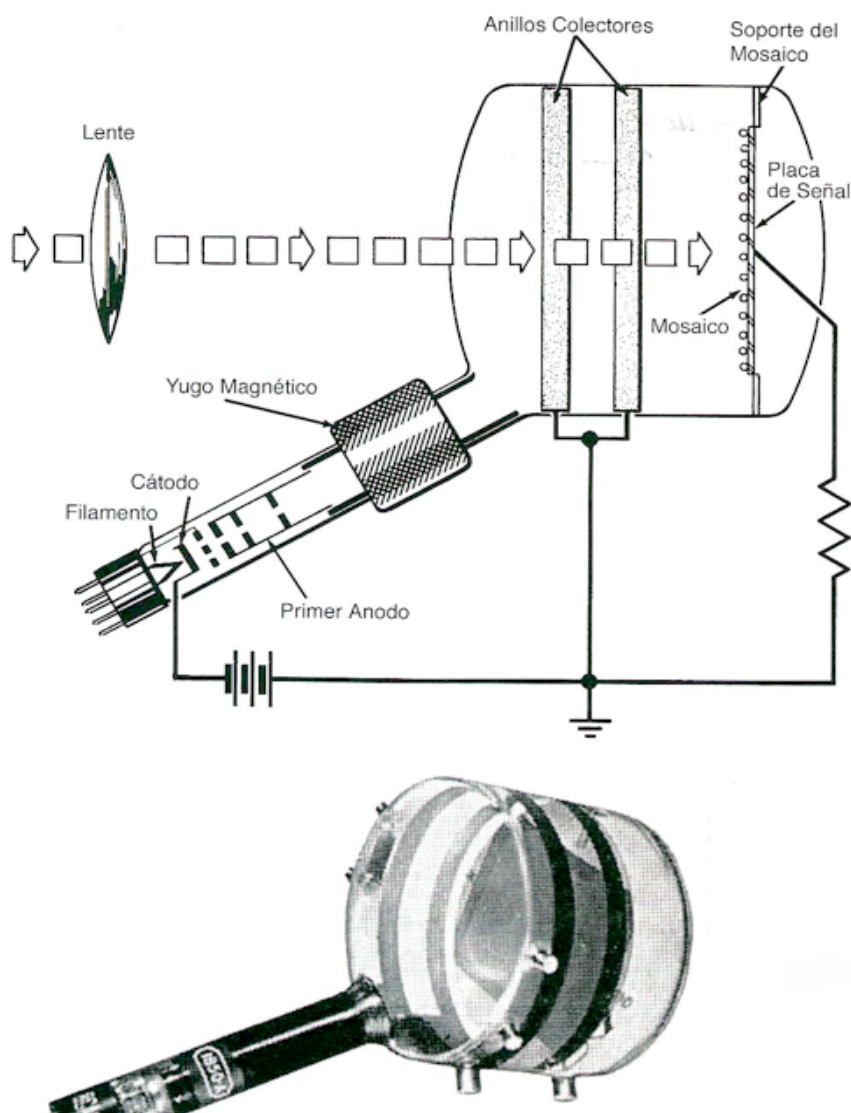

Figure 13. Iconoscope (Pérez and Zamanillo 2003)

This system was successfully tested, and in 1925 a new patent was registered based on the same principles but already working in color. With the implementation of an entirely electric system, television was born as we have known it to the present, although nowadays it is already highly evolved and in constant process

of transformation after the advent of digital technologies. The first major event broadcast on television was the 1936 Berlin Olympics, and shortly afterwards, in addition to Germany, the system was adopted by NBC in the US. So after 1939, television was broadcasted regularly on both sides of the Atlantic, although very soon the Second World War began and the uses of television and communication systems would be diverted to warlike purposes, and so, e.g. in 1942, television was used as a means of air surveillance, but that is another story.

Later, other CRT systems were developed, such as *vidicon*, although the underlying principle for the generation of the television signal remained the same, obtaining successive electrical signals of variable intensity depending on the luminosity of the scene using a more or less sophisticated photoconverter system, but very efficient for both the capture and the monitoring of images as we see below.

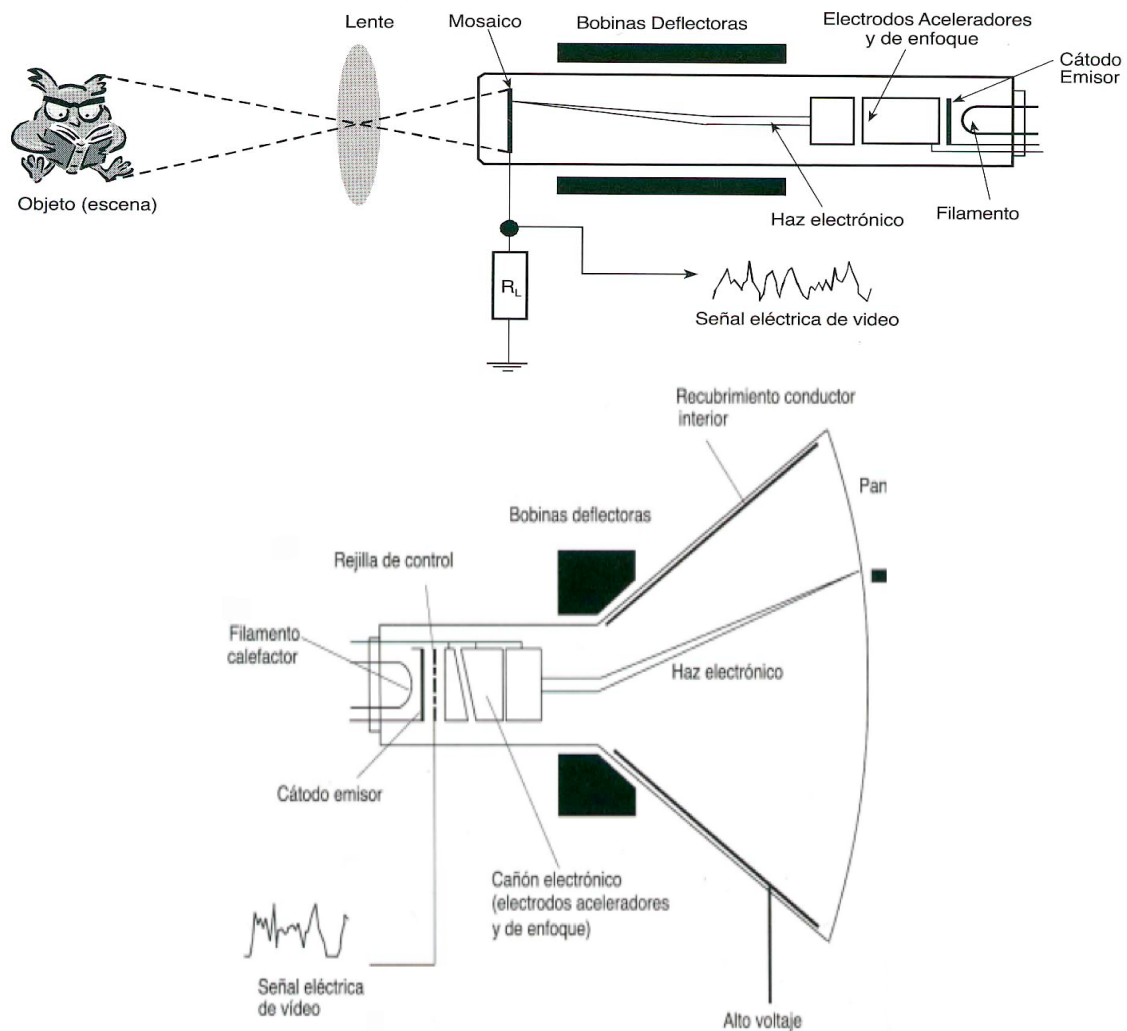

Figure 14. CRT's operation on TV image capture and reception (Pérez and Zamanillo 2003)

Thus, exploring the image in the capture and reproducing it in a synchronized way in the projection equipment, both with electronic operation based on CRT, it became possible to elaborate a television image, initially in black and white.

In a test chart such as the one below, by recording the differences in brightness and converting them effectively, line by line, in electric pulses of variable intensity, a complete image is obtained, which is restored during the projection following the same patterns, although naturally in black and white, just like television systems were designed in the beginning.

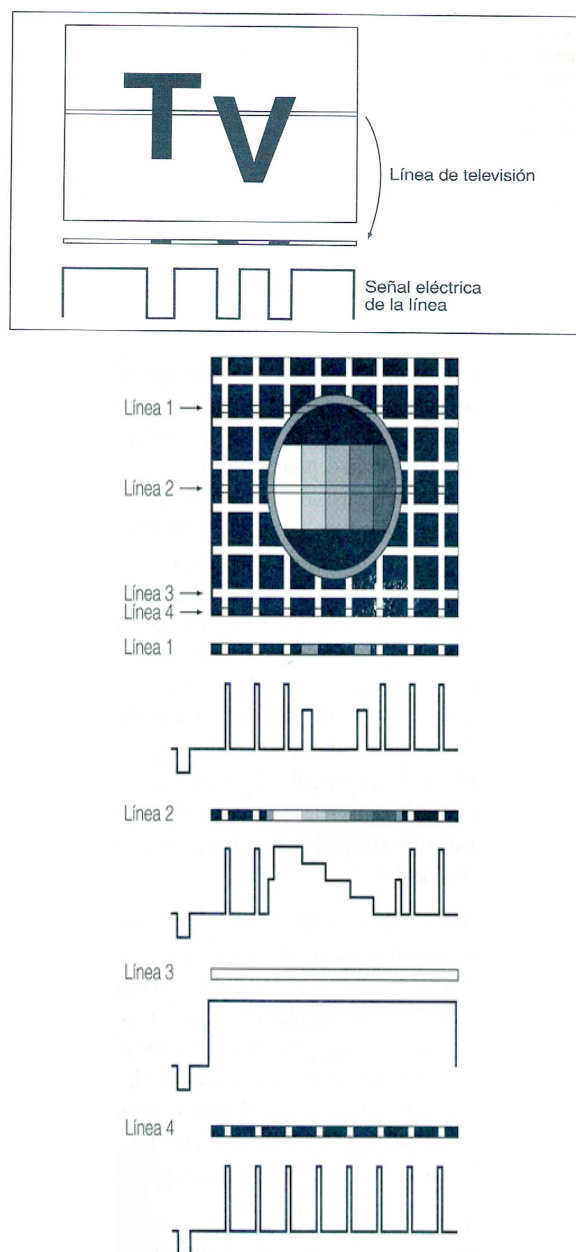

Figure 15. Exploring a line and test card (Félix Molero 2006)

With regard to color television, the fundamental principles of color imaging systems had been known for a long time, from Newton's early research on light to the later works of Maxwell, among others. At the beginning of the development of television, photographic and cinematographic technologies were used to allow the capture and reproduction of color, and as we discussed above, the first tests of color television began in the 1920s. The challenge of color television consisted in the construction of equipment based on the principle of separation of primary colors in order to be able to generate images with a chromatic richness similar to that of the visible spectrum. To learn more about the chromatic theories you can consult the teaching material of the subject Technology of Communication.

The first color register equipment had three cathode ray tubes and a filter system that allowed the visible light to be decomposed and direct each of the primary colors to its corresponding tube. However, these cameras, although evolving over time and gaining in lightness and precision, always presented constant problems of adjustment and synchronization and towards the end of the century were replaced by camera systems based on matrix sensors, whose characteristics we will see later on, and which allow to register color images with the same principles, as we see below, using dichroic filters for the separation of the color integrated in the optical block.

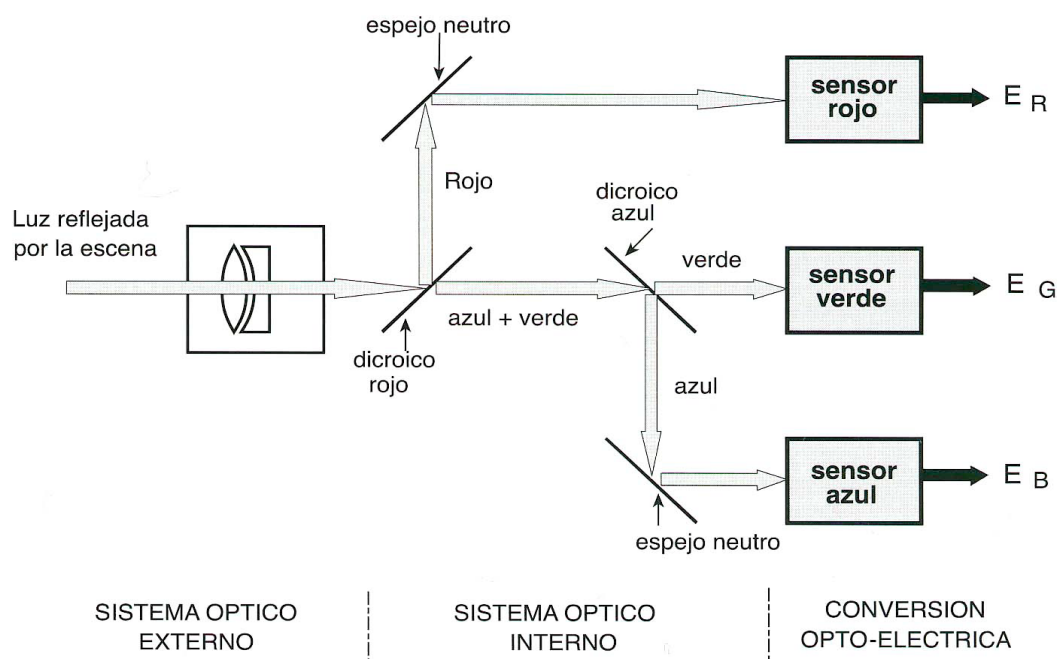

Figure 16. Optical System for Color Analysis (Pérez and Zamanillo 2003)

The optical color system analysis of current capture systems is the first that intervenes in the shaping of the image in any camera equipment and allows multiple

operations to regulate the characteristics of the image prior to its registration and electronic treatment. We can see below the typical controls that we can find in a usual optics in the current camera equipment, many of them automated.

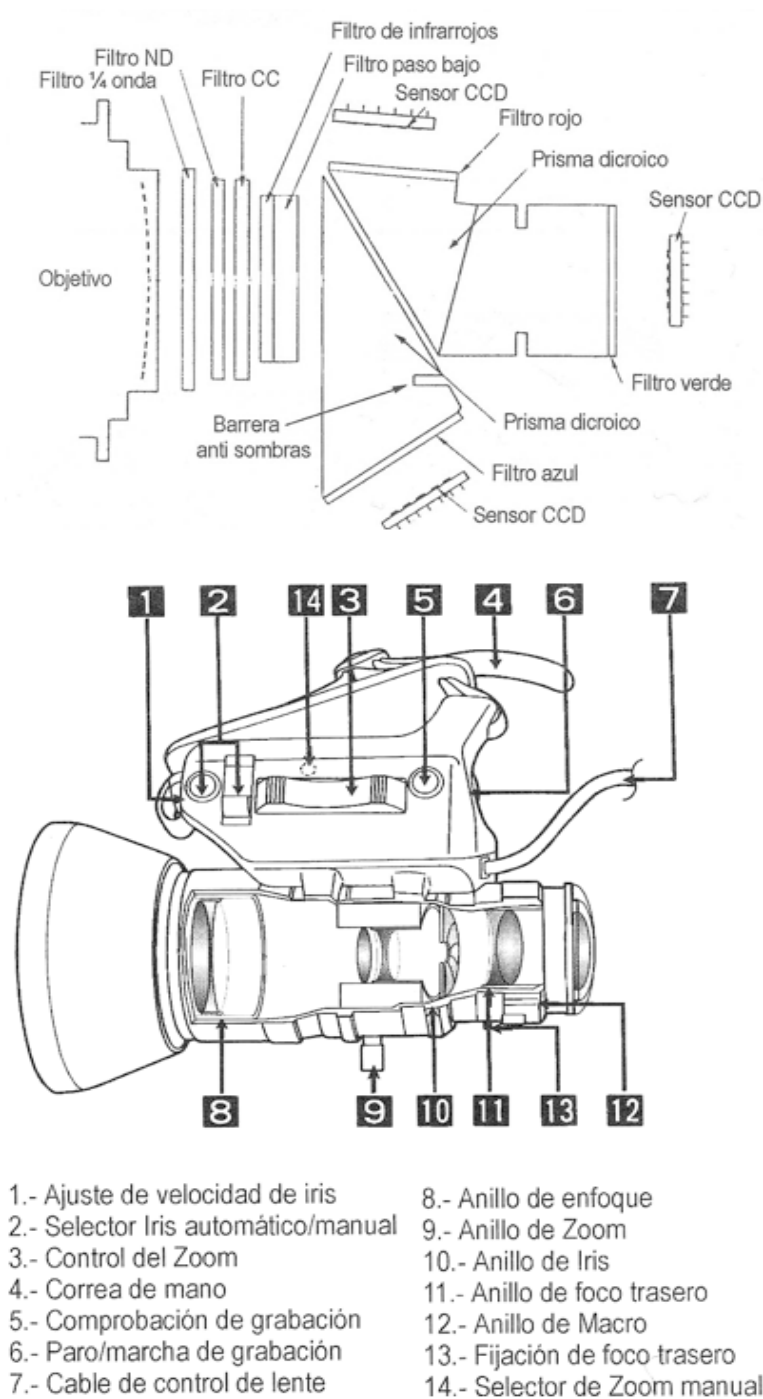
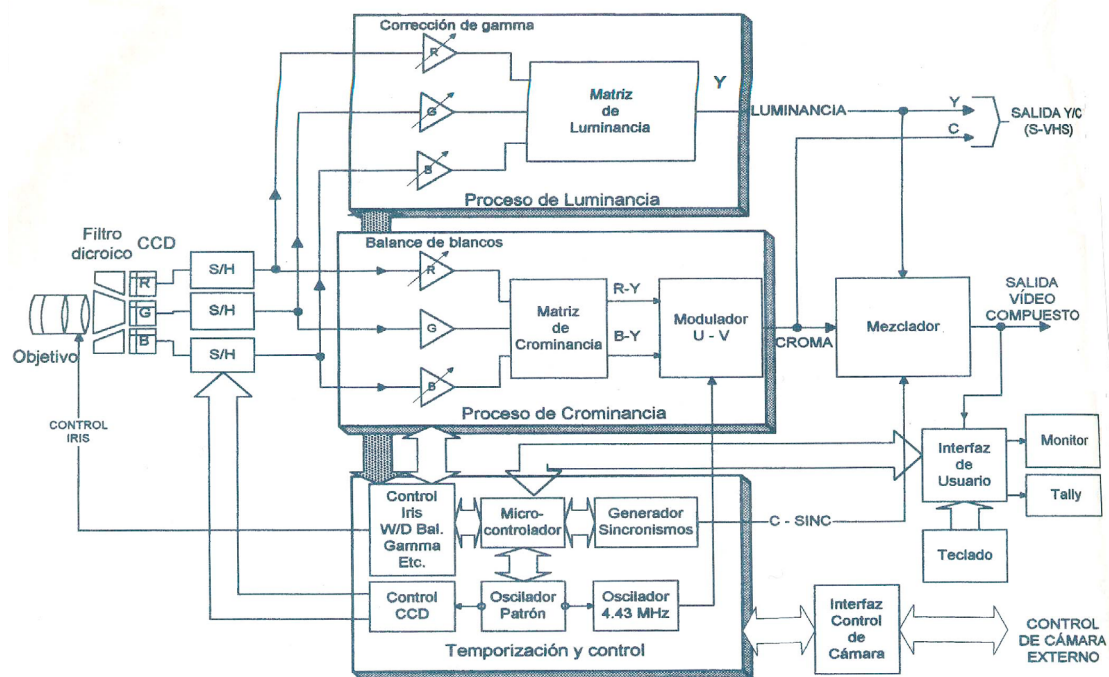

Figure 17. Optical block and controls on zoom lens (Félix Molero 2006)

In the next functional block of the capture equipment, the optical-electronic conversion is performed and the video signal is generated in color. The information

directly received from the sensors could be treated and compressed, and it would also be possible to maintain the original signal corresponding to the red (R), green (G) and blue (B). This option, however, providing the highest quality, is only possible by assuming a high cost of the equipment due to the multiplication of the electronic circuits and the complexity of the construction system, and for this reason color coding strategies are simplified in their construction and their costs are reduced by using several methods.

The first method consists in separating the luminance (Y) from the chrominance (C) information, which is therefore named a *Y/C color* or *separate* video signal, so that for practical purposes the resulting signal is separated into the two values, i.e. two physical wires, normally mounted on the same connector. The second of the systems capable to insert in a single electrical signal all the information of color that, as explained above, comes from three different signals corresponding to each one of the RGB primary colors, uses an integration method that, although of less quality, results in a single video stream, i.e. only one physical wire through which all information is transmitted, and therefore this signal is called *composite* video. This type of signal is the one that has been used to transmit color images at a distance, in other words, which has allowed color television.



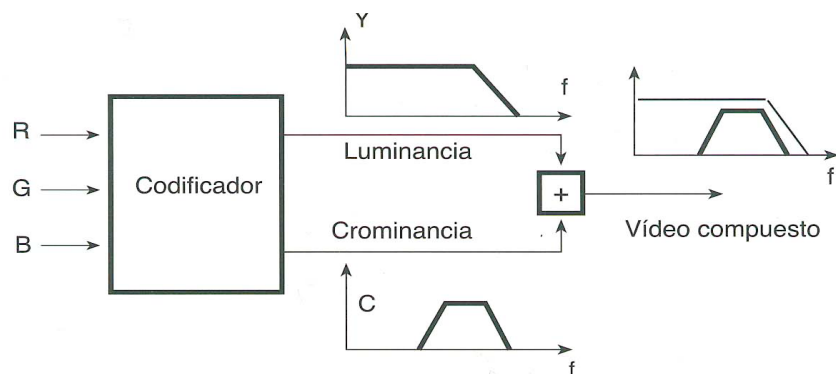

Figure 18. Camera converter block and generic composite video system (Félix Molero 2006)

The signal we see in the previous graph with UV modulation corresponds to the coded signal in the PAL system, one of the color television systems used for television, although there are others such as NTSC or SECAM, all already becoming obsolete due to the implantation of Digital Television, which we will deal with in another chapter.

2. The Digital Video Signal

Summary

In this second section of the textbook, the digital video signal is analyzed in detail, especially the characteristics that determine the final quality of the output image as the result of the digitization process, as well as the most widely used digital videorecording systems.

Firstly, we study the parameters that influence the quality of the image during the capture and scanning process; secondly, we analyze the importance of encoding and the use of compression algorithms throughout the process of digitizing images and sounds. Finally, we study the different media storage systems that are used for recording and archiving the digital video signal.

Nowadays, all video systems are based on digital technology, and the production equipment is designed to be integrated into a workflow that efficiently captures, records, processes and monitors the digital video signal throughout the production process.

As can be seen below, at the input of the system is the camera equipment, based on the operation of sensors that allow the capture of images in the form of digital data by forming a raw signal (RAW) which can subsequently be converted into other formats for processing, recording and monitoring.

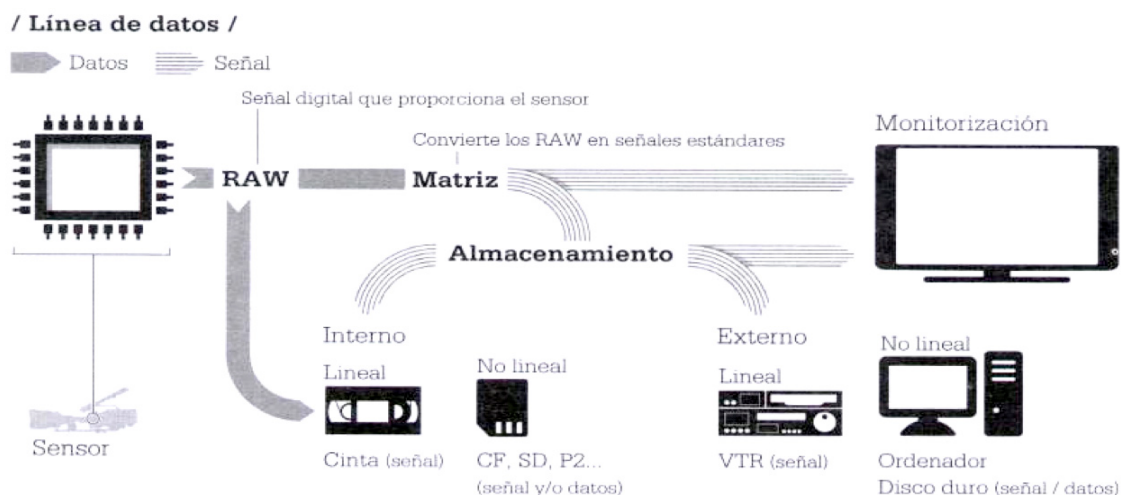

Figure 19. Digital Video System (Carrasco 2010)

In the following sections, we will focus in detail on the phases and equipment that make up any digital video system, and the basic terminological concepts and common use in the professional field of audiovisual production of our days.

2.1. Digital Image Capture

The latest technological developments that are being implemented in the technologies of capturing moving images are determined by the new advances in the capture systems that in the last 20 years have replaced the not very practical cameras based on cathode ray tubes for MOS sensors.

As we have seen in the previous chapter, at the beginning of television there were the experiments with imaging systems built by using photosensitive cell matrices, although not until the last third of the twentieth century did the adequate technological conditions exist to be able to develop systems with these advantages, mainly thanks to advances in microelectronics with the progressive integration of circuits in microchips and the mastery of new semiconductor materials that made it possible.

In this way, it was possible to begin to reduce the size and weight of the imaging equipment systems by replacing the tubes by photosensitive sensors and the cumbersome electronic circuits with electronic microcircuits that allow the analysis and treatment of the information that they register. Current sensors are based on a doped silicon MOS (Metal-Oxid Semiconductor) capacitor whose electrical charge depends on the intensity of the light energy it receives. Many of these photosensors arranged in a matrix allow the analysis of the image point to point. The rate at which the transfer of electrical charges is carried out will determine the cadence in the image registration and the total flow of data that the system needs to work both for transfer and for recording and monitoring.

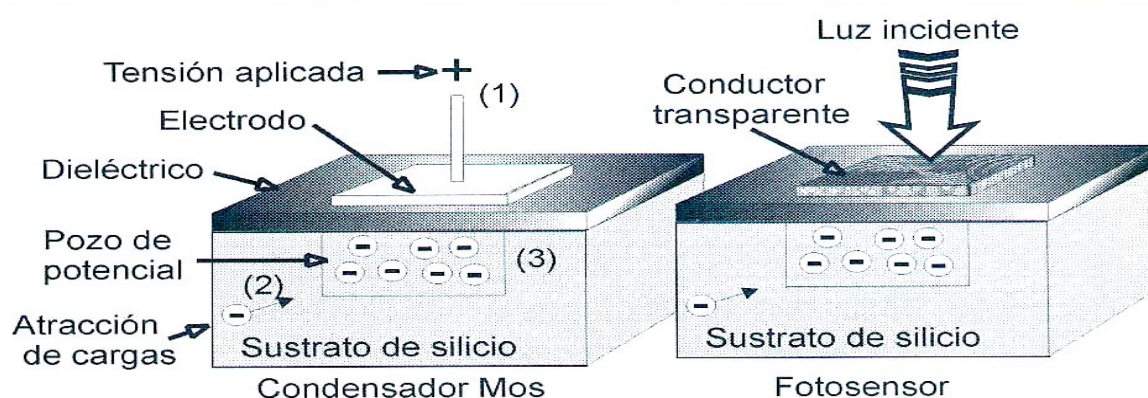

Figure 20. MOS Sensor (Félix Molero 2006)

The current trend is to integrate CMOS imaging systems, working in a similar way such as CCD sensors, that is, as coupled capacitors, although unlike them, the transfer charge is not done in a sequential manner, but each cell has its own transistor that detects and stores the charge and can also amplify and treat it in an individualized way, thus allowing operations on sets of cells or windows of interest. Thereby, CMOS sensors offer obvious advantages, such as greater integration of functions (white balance, level and speed of exposure, autofocus, etc.) that can be controlled electronically during shooting directly in the sensor, and other advantages of no less importance such as the reduction of size, consumption and price as well as the possibility of commercializing more compact cameras.

The latest developments are determined by the suitability of the sensors for use in High-Definition digital cinematography equipment, greatly increasing their resolution and sometimes arranging cells with orthogonal shape to increase their sensitivity, and adopting matrices with dimensions of 24x36mm for greater ease of integration in the film industry by adapting to the 35mm film format, and therefore be able to use the optics and accessories already existing on the market.

After the information is sent in a continuous electric flow of values corresponding to the reading of each cell line to complete the image recorded in the matrix, the usual process of digitizing the signal in any analog / digital conversion system is done, giving as a result an encoded signal suitable for processing with digital video systems.

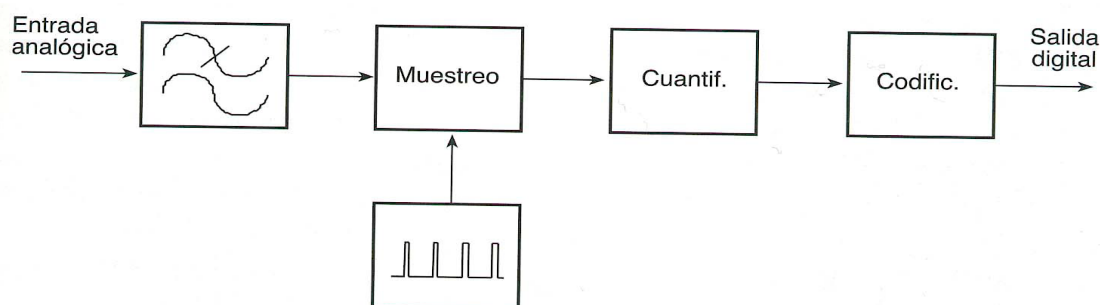

Figure 21. A/D Analog / Digital Conversion (Pérez and Zamanillo 2003)

Thus, at the input of the digital video system, we must always carry out an analog / digital conversion process that transforms the images captured by the sensor into digital data through a process of sampling, quantification and coding.

In this block of input of any digital system, therefore, the final quality of the digital image signal achieved is established by various parameters, such as resolution, sampling frequency, color depth and cadence of images obtained.

Firstly, the density of photosensors that the matrix integrates will determine its resolution, i.e. the size of the image that we can obtain, calculated as a function

of the total number of pixels (short for Picture Elements) per row and column that integrates the sensitive matrix used for capture. The most common capture resolutions currently start at 1920x1080 pixels on HD (High Definition) systems, and camera equipment with 2K and higher sensors, especially at 4K, is being implemented quickly and allowing 1:1.85 and 1: 2.39 aspect relation following the DCI norms of digital cinema.

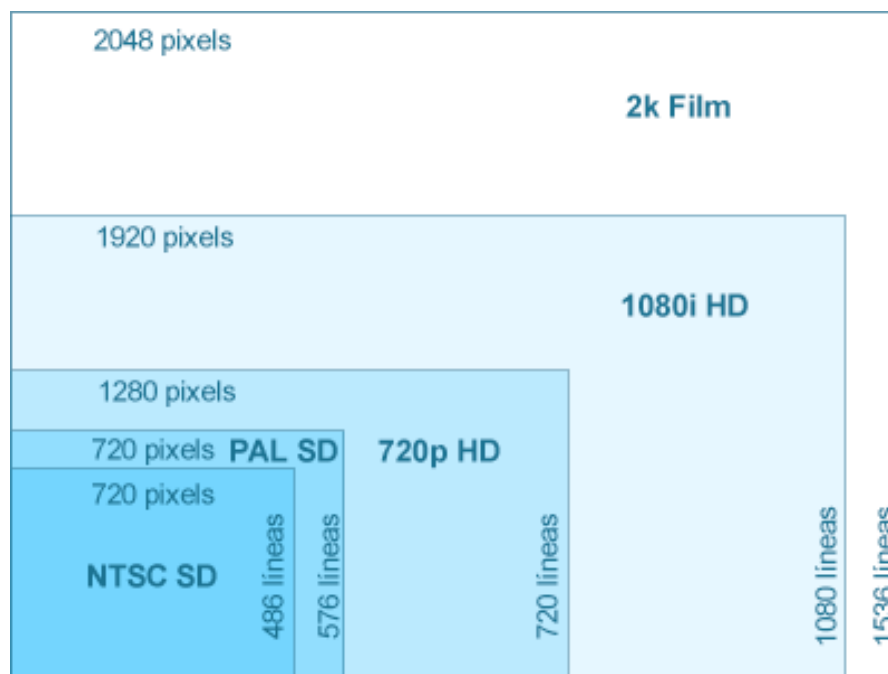

/ Resoluciones DCI para cine: 4K /

4K (4.096 x 2.160)



Figure 22. Different image resolutions in PAL, HD, DCI 2K and 4K formats (Carrasco 2010)

For the monitoring or projection of digital video, as we see next, there are different resolutions for the screen, but all of them are scalable from the standards that can be obtained by the sensors used during the capture and normalized for the production of digital cinema in DCI format, that is already evolving towards 8K.

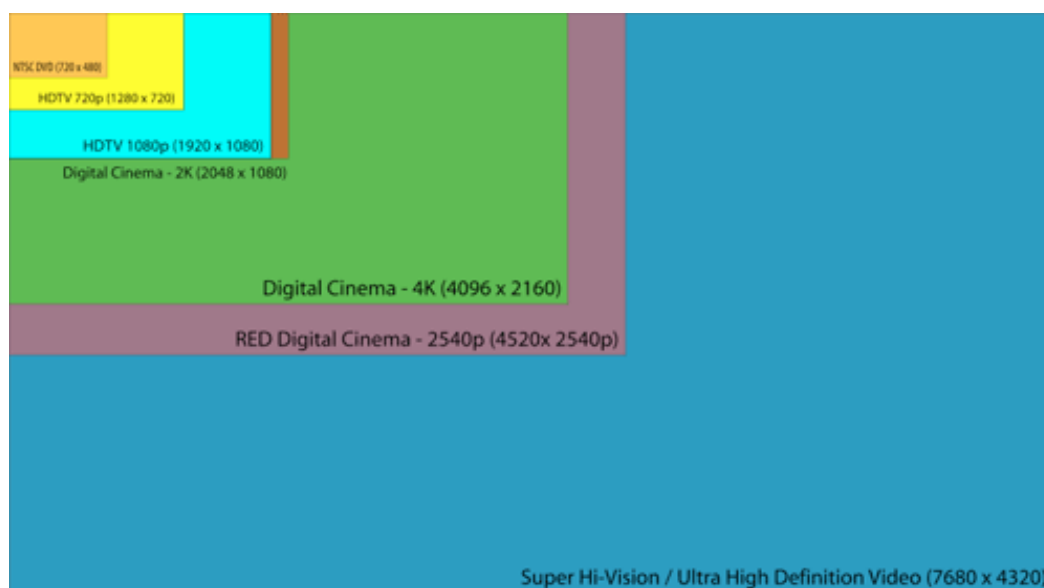

Figure 23. Monitoring and digital projection formats (www.proav.de)

Secondly, all the information captured pixel-to-pixel in the sensor in the form of differences in electrical intensity proportional to the luminous intensity of the recorded scene are to be converted into digital data by the process of sampling, quantifying and encoding the signal.

Signal sampling is defined as the speed at which the data supplied by the sensor is read, and it is closely related to the volume of information to be extracted and the number of images per second, i.e. the image cadence. That is, for a sensor with HD resolution that provides a standard television signal at 25 frames per second in progressive mode (25p), we will have a data stream that will result from multiplying the 1920 x 1080 pixels of each image by 25, in total 51,840,000 points per second. As a result, and taking into account that to explore the output electrical sinusoidal signal of the sensor must be sampled twice its frequency, if you do not want to lose information according to the Nyquist formula, we should do it at a speed of approximately 100 million times per second, i.e. 100Mhz (megahertz).

With this sampling frequency we would obtain a signal of quality regarding the volume of data, but to obtain each one of them we must still quantify the original analog signal captured by the sensor in order to be able to assign a precise binary value to each pixel according to its electrical intensity. This process, named quantification, is critical, and depending on the amount of bits we use we will be able to obtain better or worse quality results in the digital signal. As we see next, in a

conventional digital system of three sensors, one for each RGB color, if we use 8 bits per channel / color we will be able to obtain a maximum of 256 different colors, whereas if we quantify the signal to 12 bits per channel the number of different colors increases up to 4,096. That is, if we capture an image with great color richness its quality will be strongly compromised if our system of digitization provides a color depth of the signal to 8 instead of 12 bits per channel, which would be optimal.

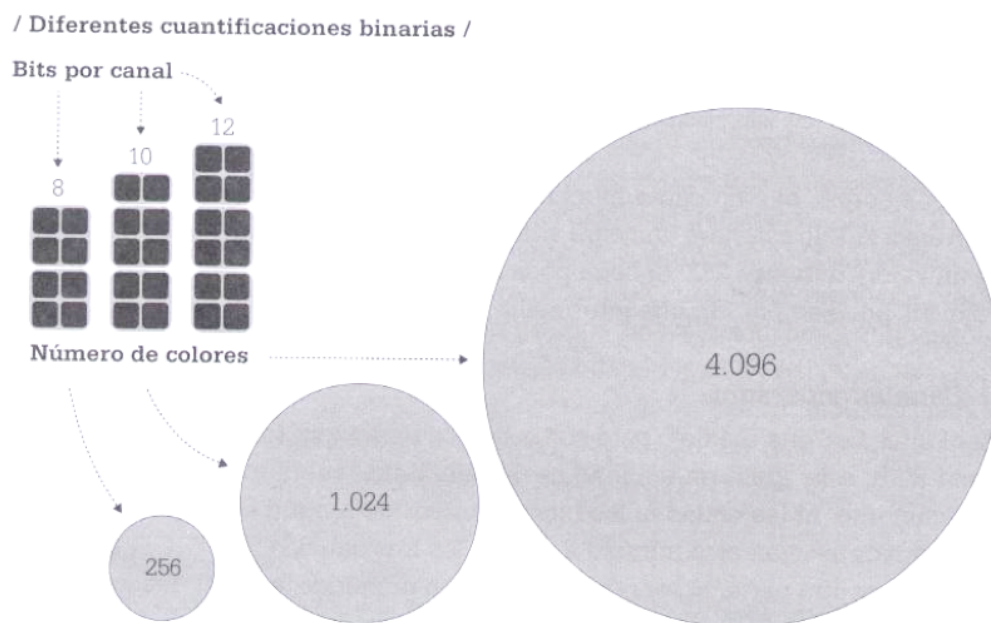

Figure 24. Color Depth (Carrasco 2010)

Of course, the total data stream, calculated in numbers of bits, will increase significantly if we work with a color depth of 12 bits instead of just 8 bits. That is, a total of 50 million pixels can result in a data stream of 50x8 or 50x12 million bits per second, then a bandwidth of 400Mb or 600Mb per second, which implies different requirements and technologies for the system in terms of the transport and processing of the digital signal.

Likewise, the way we do the color sampling, as we will see a later on, will address a larger or smaller file size, increasing more or less the resulting data flow that will need to be handled throughout the production process.

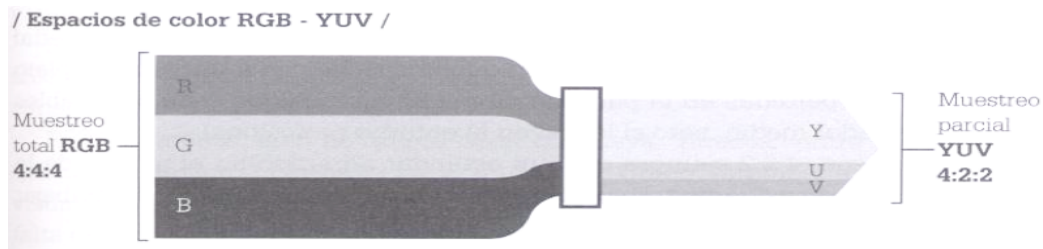

Figure 25. Color Sampling (Carrasco 2010)

Moreover, as we see below, the choice of one cadence of images or another results in an immediate effect on the quality of the digital image, also as regards the data flow that the system must handle. And it is not the same for the sensor to explore interlaced (i) or progressive (p) scans, or a cadence of 25p or 50p.

/ Desplazamientos /

Captación interlazada

Sólo dos campos unidos en un cuadro dan una información completa



Captación progresiva



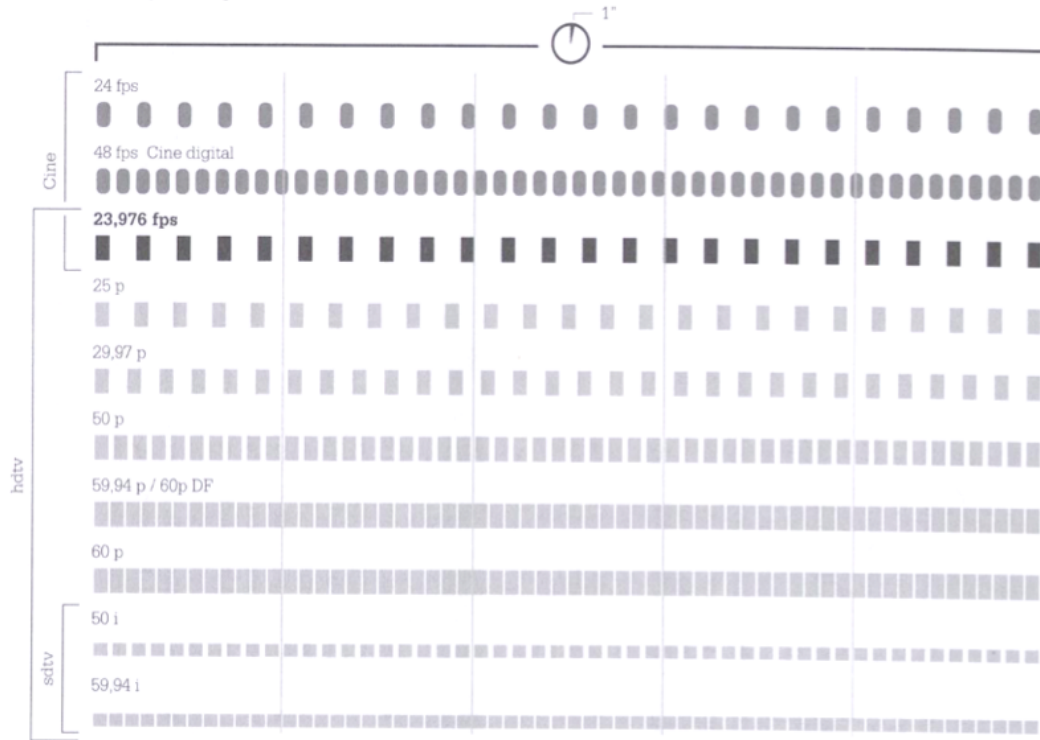

Figure 26. Interlaced and progressive scan and cadence (Carrasco 2010)

Finally, as a result, the total uncompressed data stream for each of the different digital video production formats ranges from 70GB to 3.76TB per hour, which in terms of processing and storage capacity implies important equipment requirements and integration in the digital production system.

Tabla de pesos y flujos de datos sin comprimir

Formato	resolución	muestreo	p. bits	PESO MB/f	cadencia	BITRATE	1 hora
SD576	720 × 576	4:2:2	8	0,79	50i	158 mbs	70 GB
HD720	1.280 × 720	4:2:2	8	1,76	25/60p	350/844 mbs	154/370 GB
HD1.080	1.920 × 1.080	4:2:2	8	3,96	25p	800 mbs	350 GB
HD1.080 RGB	1.920 × 1.080	4:4:4	10	7,42	23,976/25p	1,39/1,45 gbs	652 GB
2K DCI	2.048 × 1.080	4:4:4	12	9,49	48p	1,8 gbs	800 GB
2K FA	2.048 × 1.536	4:4:4	10 log	11,25	24p	2,11 gbs	950 GB
4K DCI	4.096 × 2.160	4:4:4	12	37,97	24p	7,12 gbs	3,13 TB
4K FA	4.096 × 3.112	4:4:4	10 log	45,59	24p	8,55 gbs	3,76 TB

Figure 27. Uncompressed data flow and file size on each format (Carrasco 2010)

2.2. Audiovisual Coding and Compression

As we have seen, the digital image is the result of several processes or successive phases that we have schematically called sampling, quantification and coding. And the digital signal will represent the original image with greater precision and quality according to the characteristics of the sensor used for the capture and the way in which the scanning process is carried out.

In the final phase of the digitization process, the coding phase of the signal, the sequencing of the data is performed according to the digital video format obtained as a result and, also, of the compression algorithms which are applied to reduce the flow signal amount of data to make it tractable by digital processing systems. In this phase, as in the previous ones, the quality of the obtained signal is conditioned by the type of process that is carried out, in this case by the algorithms applied for the conformation of the signal in the determined video format and the type of compression applied to the data and the way of treatment for the color.

The first digital video systems started to be useful towards the end of the 1980s, and a few years later Sony's Betacam Digital, was marketed which was expected to replace the very widespread and solvent format Betacam SP which was analog, thus initiating a digital transition, by now virtually completed, that has been unstoppable since then and that has radically transformed the audiovisual sector in recent years.

The first digital video formats were promoted from within the Digital Video Broadcasting Group, DVB, an organization in which the largest industries of the sector and other public and private partners with diverse interests in the audiovisual field participate. Their objective was the optimum development of digital video formats for marketing and their implementation as market standards. As a result, the work of the DVB group resulted in the standardization of various digital formats, formats named D, with specific characteristics for each type of application, from which marketers have been developed their own brands such as DV or DVCPRO.

Formato	Submuestreo	Bits/pixel	Compresión	Mb/s
D-1	4:2:2	8	1:1	172
D-2	Compuesto	8	1:1	94
D-3	Compuesto	8	1:1	94
D-5	4:2:2	8 ó 10	1:1	220
D-7, DV, DVCAM, DVCPRO	4:1:1 ó 4:2:0	8	Intra 5:1	25
D-9, Digital-S, DVCPRO50	4:2:2	8	Intra 3,3:1	50
Digital Betacam (Sony)	4:2:2	8/10	Intra 2,3:1	95

Figure 28. DVB Video Formats (Millerson 2009)

In relation to the compression systems something similar has occurred, in this case grouping within the Motion Picture Expert Group, MPEG, the industry and organizations with interests in the audiovisual sector in order to improve the quality of the compression algorithms, developing diverse rules depending on the characteristics and the use to which the images are destined.

In this way, the MPEG-1 image-oriented compression algorithm was developed for users who do not require a high quality of image and prefer to reduce it in favor of storage capacity. The specific application for audio compression known as MP3 stems from this format, which is a result of MPEG1-Layer 3 algorithm.

The MPEG-2 compression system, however, is oriented towards professional and broadcast applications as it provides a high quality of image that allows even broadcasting in HDTV, i.e. in High Definition TV. It is a sophisticated and efficient compression system that uses intra-and interframe compression, and it also allows a variable data flow depending on the specific use, resulting in a data flow for 4 to 100 Mb/sg.

/ Familias de compresión /

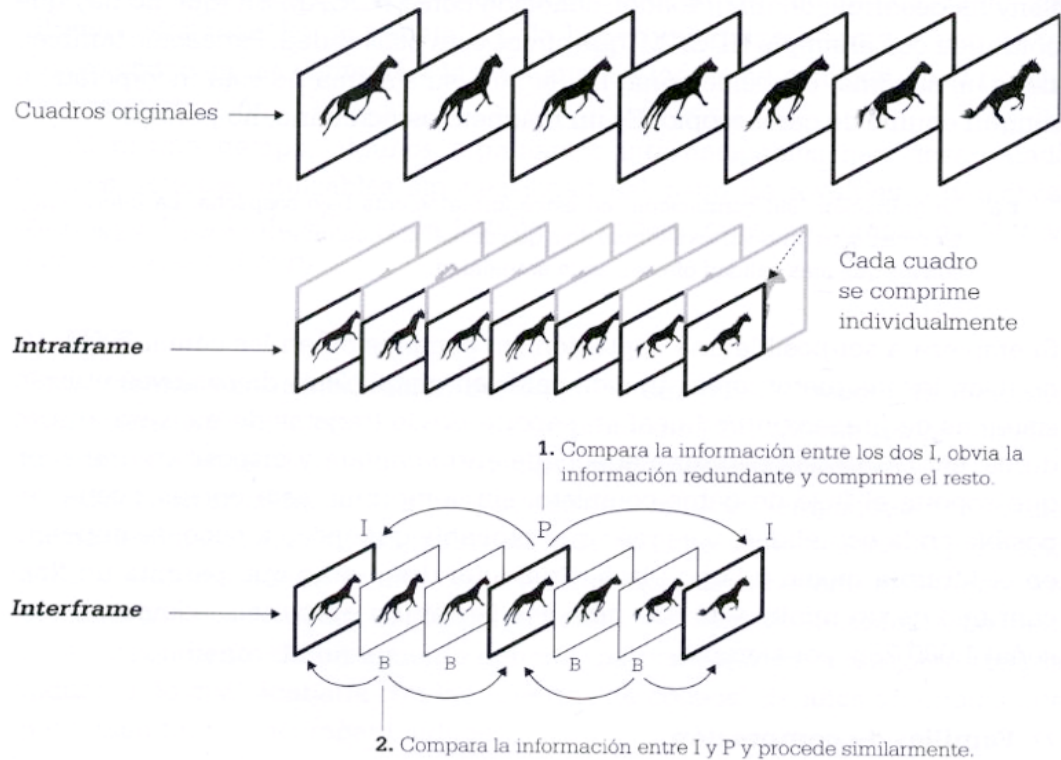

Figure 29. MPEG Intra and Interframe Compression (Carrasco 2010)

In order to maximize the quality by reducing the amount of data, the MPEG-2 system divides the image into 8-pixel blocks before applying the compression algorithm called DCT. To complete its efficiency, spatial compression is also applied. In this way, it defines several types of frames called I, B and P, i.e. index bidirectional or predictive images, to which intra-DCT compression is practiced. Predictive images which refer to previous I and P images only contain the information of the changes produced with respect to those in vectorial form. In bi-directional images, the maximum compression is applied when referring both to the previous P or I images. The major or minor compression of the I and P images and, above all, the major or minor presence of B images, determine the complexity of calculation that must be done and the smoothness perceived by the spectator of the transition between the successive images and later in the final quality results.

Some other systems have been developed within this MPEG group of experts, such as MPEG-3, originally intended for HDTV but abandoned, and MPEG-4, with an algorithm for the coding of audiovisual objects oriented towards the transmission of Internet video at low speed, in the range of 28.8 to 500 Kb/sg, that has had huge success resulting in the well-known DivX and Xvid systems. Another standard developed by the MPEG group, although it does not contain any compression algorithm, is the so-called MPEG-7, suitable for the description of audiovisual contents to facilitate indexing in databases and documentary searches

in order to make possible the semantic interpretation of audiovisual information, an area in which, in recent years, a significant and necessary impetus is being generated, which is giving rise to various formats of data files that can facilitate the cataloging and exchange of audiovisual information.

In addition to the resulting MPEG formats, there are other compression systems, such as the H.263 and some others, which are gaining momentum in the market due to their effectiveness for processing and data transfer. Also, as we will see below, there are several standards specifically designed for audio compression, such as PCM or MPEG-2 AAC, intended for high fidelity audio systems and used as MPEG-2 for professional applications, as HDTV and Blue-Ray recording systems or similar.

Estándar/Formato	Ancho de banda típico	Ratio de compresión
CCIR 601 (D1)	172 Mb/s	1:1 (Referencia)
M-JPEG	10-20 Mb/s	7-27:1
H.261	64 Kb/s – 2000 Kb/s	24:1
H.263	28,8-768 Kb/s	50:1
MPEG-1	0,4-2,0 Mb/s	100:1
MPEG-2	1,5-60 Mb/s	30-100:1
MPEG-4	28,8-500 Kb/s	100-200:1

Formato	Frec. Muestreo (KHz)	Canales	Caudal por canal (Kb/s)	Uso
PCM (G.711)	8	1	64	Telefonía
CD-DA / DAT	44,1/48	2	705,6/768	Audio Hi-Fi
MPEG-1 Layer I	32/44,1/48	2	192-256 variable	
MPEG-1 Layer II	32/44,1/48	2	96-128 variable	
MPEG-1 Layer III (MP3)	32/44,1/48	2	64 variable	Hi-Fi Internet
MPEG-2 AAC	32/44,1/48	5.1	32-44 variable	Hi-Fi Internet

Figure 30. Video and audio compression formats (Millerson 2009)

2.3. Storage Media Systems

As we have already seen (see for this the Communication Technology Manual), the recording of the signal itself is currently carried out using mostly magnetic technologies, magneto-optical recording media and solid-state memories such as flash memories. The magnetic tape is in the process of being replaced in all the production equipment, just like the CD-type or DVD-BlueRay type are only still in use for archiving and the distribution of audio-visual files within the domestic

market. Camera equipment requires direct recording with solid-state type memory cards and, in complex and studio productions, the use of external recording media based on magento-optical discs is usual.

There are several reasons for using flash memory instead of other recording media systems, such as that they do not make any noise, allow quick access and, above all, are light, very small and also have no moving parts which makes them especially suitable for transportation and use. In addition, their costs are very low and they are reusable, all of this is very useful to make them solvent candidates to become the support of all digital equipment in the domestic and professional field. Evidence of this is the commitment first by Panasonic, and later also by Sony, to use this technology in systems such as both the P2 and the SxS Pro, which are based on flash cards with high storage capacity.

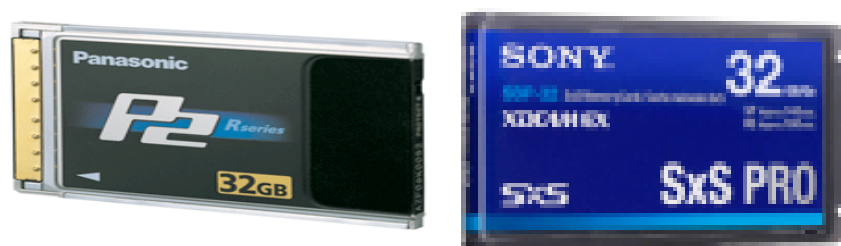

Figure 31. P2 and SxS Pro Memory Cards (www.panasonic.com and www.sony.com)

However, it is still very common in many production centers, especially in schools, to use the DVCAM / HDV system, a particular development of the DV format that uses tape and magnetic technology as a recording medium marketed by Sony whose characteristics allow it to be used for recording broadcast images without visible differences in quality compared to other more professional systems, although these exist. The inconvenience of this system is that the images are recorded on magnetic tape, even if they are digital, which has to be converted into a computer file suitable for its treatment by audiovisual postproduction systems, with the consequent cost involved in resources and working hours.

To summarize, the destination of all audiovisual recording nowadays is a computer file containing the digitally registered audiovisual information. We can find a multitude of systems with very diverse differences which determine the structure of the video and audio data, but at the end their performance depend on the digital process and the codecs used for the compression of the data, which will significantly determine the final quality of the recorded digital image.

Extensión del archivo	Contenedor	Códec de video	Resolución	Velocidad de transferencia (fps)	Velocidad en bits (Mbps)	Códec de audio		
*.avi *.mkv *.asf *.wmv *.mp4 *.3gp *.vro *.mpg *.mpeg *.ts *.tp *.trp *.m2ts *.mts *.divx	AVI MKV ASF MP4 3GP VRO VOB PS TS	DivX 3.11/4.x/5.x/6.1	1920 x 1080	6-30	30	AC3 LPCM ADMPCM (IMA, MS) AAC HE-AAC WMA DD+ MPEG (MP3) DTS Core		
		MPEG4 SP / ASP						
		H.264 BP/MP/HP						
					Motion JPEG		640 x 480	8
					Window Media Video v9		1920 x 1080	30
					MPEG2			
					MPEG1			

Figure 32. Types and file extensions of audiovisual archives (Beach 2009)

3. Digital Production Systems

Summary

In this third section, we study the characteristics and equipment of digital production centers, with the aim of providing a panoramic view of the current technological context in which the audiovisual professional production processes develop at present.

We analyze the digital systems and equipment used in the field of professional production and the technological trends that are becoming widely established in the different operational areas of television production centers.

All systems developed within the DVB and MPEG and other existing groups of interest have become part of a set of global standards taken over by the International Telecommunication Union (ITU), adopted by a vast majority of countries in the world. In Spain, the Spanish Agency for Standardization (AENOR) is responsible for establishing rules in the telecommunications sector, in conjunction with other ministerial sections and entities of interest in this area. The standards resulting from the work developed by the ITU are mandatory throughout its territory of implementation and for all its members, by virtue of the agreements established between the participating countries. In addition to standards, ITU also promotes sectorial studies and recommendations that are not mandatory in their areas of competence in order to facilitate, in general, the economic and industrial development of the telecommunications sector. One of the International Consultative Committees created within the ITU is Radiocommunication, first called CCIR, now ITU-R, in order to be responsible for defining transmission standards and establishing the reserve of channels in the radio spectrum for each type at the global and national level, and thus, to dissipate any dispute between countries, which in these days are minor but which were very intense in other times.

3.1. Audiovisual Production Systems and Formats.

Within the ITU-R, the Study Group 6 was created to combine criteria and dictate common rules for video recording, with the ultimate aim of normalizing the audiovisual production equipment in the face of constant technological advances and the multiplication of formats. The Study Group 6 is only the final link of an industrial R & D & I system in which corporations with global interests such as Sony, Panasonic, JVC, Thomson, etc. have great decision-making power.

Grouped into various entities and work groups, such as the aforementioned DVB and MPEG, impose technological developments following their own industrial and marketing strategies in the audiovisual equipment market. The ITU-R Study Group 6, therefore, only collects the work of third parties in an attempt to make feasible and reasonable audiovisual equipment systems in the vicinity of global telecommunication systems. But with limited real power, it is the market itself and the multinationals themselves that dictate the direction of technological changes in function of their interests, especially in the field of equipment and technologies of audiovisual production.

For video formats and systems, what has been done by ITU-R and the ITU-R Recommendation BT.601 was to synthesize the generic aspects of new technological equipment into regulatory developments resulting in three different levels of production as a function of coding of the color that is realized, corresponding with those established from DVB but giving them character of global norm.

The first of these standards is the so-called ITU-R Recommendation BT.601 4:4:4, which establishes the characteristics of a component video format, RGB or Y, RY and BY, which allows maximum quality and copying without loss because it does not have any compression, but at the cost of a high data flow, 249 Mb/sec at 8 bits per channel, which means that each second occupies approximately 31 MB.

The second normative development, and the most used, defines a format of lower quality but suitable for the professional production and study market known as REC. 601 4:2:2. Unlike the previous one, it uses half of information to sample the color in relation to the luminance signal, taking advantage of the characteristics of the perception that allows to reduce the flow of data without appreciable losses of colorimetric quality, reducing significantly the volume of data.

The third standard promoted within the ITU by this Study Group is called REC. 601 4:1:1 or REC. 601 4:2:0, depending on whether it is intended for digital information in the American NTSC or European PAL system respectively. It is ideal for the domestic market and for electronic journalism applications, because although there is an appreciable decrease in the colorimetric quality of the image, the reduced data flow needed –25 Mb per second– allows the production of audiovisual equipment of very low cost and high versatility.

In the audiovisual production sector based on the REC. 601 4:2:2 standard we can find equipment and video systems such as Betacam Digital, one of the most established patents, which has specific characteristics such as a very low ratio compression, 1.77:1, achieved with a proprietary algorithm of Sony called BRR, Bit Rate Reduction, allowing a data flow of only 127.8 Mb/sec with samples of 10 bits and four audio channels. Other systems developed with this standard are those sold in direct competition with Sony by Panasonic with its DVCPRO50, which achieves a 50 Mb/sec flow with a compression ratio of only 3.3:1, or by JVC, the Digital-S, with lower quality than the previous ones. Also, these formats compete with the new commercialized Betacam SX and Betacam MPEG-IMX, both produced by

Sony, which are integrating MPEG-2 algorithms with a different rate of compression and are addressed to specific television markets and high quality videographic productions.

With the REC. 601 4:1:1 or 4:2:2 standard, we can find the so-called DV systems in the market, based on the D7 promoted by DVB, with intraframe compression of 5:1 and a flow of 25 Mb per second. Sony derivated its own formats DVCAM and HDV, using slightly wider videotapes and, in the case of the latter, allowing a higher resolution. In the case of Panasonic, the DV format has been marketed as DVCPRO25. The DV format is generally the one that normally markets brands exclusively positioned in the domestic digital video consumer market, except for some equipment that is currently being distributed based on MPEG-4 that uses compression algorithms like DivX or Xvid, which greatly reduce the flow of data and drastically reduce costs.

Below we can see the multiplicity of existing video formats and their specific differences.

Formato	Tipo de cinta	Anchura de pista (µm)	Grabación imagen	Muestreo	Longitud de muestra	Tipo de compresión	Ratio de compresión	Flujo binario (Mbps)	Grabación de audio	Número de canales	Frecuencia de muestreo (kHz)	Longitud muestras
DV	1/4"	10	Componentes	4:2:0 PAL 4:1:1 NTSC	8	DCT Intracuarto	5:1	25	PCM	2/4	48/32	16/12
DVCAM	1/4"	15	Componentes	4:2:0	8	DCT Intracuarto	5:1	25	PCM	2/4	48/32	16/12
HDCAM	1/2"		Componentes	3:1:1	8	DCT Intracuarto	7:1:1	140	PCM	4	48	16
Betacam SX	1/2"	32	Componentes	4:2:2	8	MPEG 2	10:1	18	PCM	4	48	16
Betacam Digital	1/2"	21,7	Componentes	4:2:2	10	DCT Intracampo	2:1	95	PCM	4	48	20
D1	3/4"	45	Componentes	4:2:2	8	DCT Intracuarto	Sin compresión	175	PCM	4	48	20/16
D2	3/4"	39	Vídeo compuesto	17,72 MHz	8		Sin compresión	94	PCM	4	48	20
D3	1/2"		Vídeo compuesto	17,72 MHz	10		Sin compresión	94	PCM	4	48	20
D5	1/2"		Componentes	4:2:2	10	DCT Intracuarto	Sin compresión	270	PCM	4	48	20
D5 HD	1/2"		Componentes	4:2:2	10	DCT Intracuarto	4,5:1	270	PCM	8	48	20
D6	3/4"		Componentes	4:2:2	8	DCT Intracuarto	Sin compresión		PCM	2/12	48	20/24
DVCPRO (D7)	1/4"	18	Componentes	4:1:1	8	DCT Intracuarto	5:1	25	PCM	2	48	16
DVCPRO 50	1/4"	18	Componentes	4:2:2	8	DDCT Intracuarto	3,3:1	50	PCM	4	48	16
DVCPRO HD	1/4"		Componentes	4:2:2	8	DDCT Intracuarto	6,7:1	100	PCM	8	48	16
Digital S (D9)	1/2"	20	Componentes	4:2:2	8	DCT Intracuarto	3,3:1	50	PCM	2/4	48	16
D9 HD	1/2"		Componentes	4:2:2	8	DCT Intracuarto	3,5:1	100	PCM	4	48	16
IMX	1/2"		Componentes	4:2:2	8	MPEG-2	3,3:1	50	PCM	4	48	16









Figure 33. Digital Video Systems (Félix Molero 2006)

In the High-Definition sector, important technological advances are also being made to enable the production of digital cinema. For this specific market segment, Sony has developed what the company has called CineAlta, digital camera equipment with CCD that maintains the dimensions of the frame of 35mm, allowing to use the entire system of LP-mount lenses commonly used in traditional cinema. CineAlta has a resolution of 1920 x 1080 pixels for each RGB channel, allowing recording speeds of between 1 and 50 fps (frames, frames per second) in 4:4:4 or 4:2:2 format on videotape or hard disk.

Panasonic, in turn, has chosen to develop systems based on flash memory cards of 32 or 64GB that allow a high-speed transfer up to 64 registering minutes using the new algorithm AVC-Intra, based on MPEG-4 and of very high efficiency. Panasonic called their system Varicam / P2, adding other features to their camera equipment as a possibility to record MXF data files to identify the images, and other improvements such as wireless, USB, IEEE1394 and cable network connections that allow proper interconnection and high-rate data transfer to work with high-performance computer systems for broadcast media distribution.



Figure 35. Panasonic Digital Camera and P2 Card (www.panasonic.com)

Imager (Actual Size)	ISO	Latitude	Frame Rates (Progressive Only)	Digital Sampling on Recorded Media	Recorded Bit Depth Format & Time	Data	Weight Body Only	Power	Highlighted Positives	Notable Credits	Average National Daily Rental BODY ONLY
 CMOS 31.4mm Ø 27.7 x 14.6mm 1.90:1	800	12+ Stops w/ HDRx	1-120 fps @ 5K 1-120 fps @ 4.5K 1-150 fps @ 4K 1-300 fps @ 2K	5K FF, A2.1, 2.1, 2.4:1 4.5K 2.4:1 4K 1.6S, HD, A2.1, 2.1 2K 1.6S, A2.1, 2.1 1080 & 720 16:9	12 Bit REDCODE - 5K FF @ 7:1 128GB SSD - 40 min 256GB SSD - 80 min (HDRx cuts time in half)	3.2 GB per Minute @ 24fps	5 lbs	60W	Self Contained - Ideal for 3D HDRx High Dynamic Range Established R3D workflow Modular Design High Frames per Second	Great Gatsby ² Hobbit ³ House of Cards Justified	\$1,000
 CMOS 27.3mm Ø 24.6 x 13.8mm 16:9	850	12 Stops	24p, 25p, 30p, 50, 60i @ HD 24, 25, 30, 50, 60, 120 @ 4K to External Recorder	1920 x 1080 Outputs 2K & 4K to External Recorder	8 Bit MPEG2-4:2:2 MXF 64GB CF - 160 min 10 Bit 4K RAW to External Recorder	0.4 GB per Minute @ 24fps	4 lbs	11.4W	4K Output w/ External Recorder PL or EF mount High Dynamic Range Small Self Contained Ideal for 3D	Need for Speed Amityville Horror: The Lost Tapes Fathers & Daughters	\$900
 CMOS 27.1mm Ø 24 x 12.7mm 17:9	2000	14 Stops	24, 25, 30, 50, 60 1-380fps @ 2K & HD 1-240fps @ 2K Raw 1-60fps @ 4K Raw	2K 1920 x 1080 Outputs 4K to External Recorder	10 Bit XAVC & SR-SQ & Lite 128GB SXS - 71 min 4K ERAW to External Recorder	1.8 GB per Minute @ 24fps	5 lbs	25W	Light Weight & Small Profile Good Low Light Performance 2K Mode Uses Full Image Sensor Wide Latitude & Color w/ S-Log3 180fps Recording with SXS media	Man from Reno Parts Unknown The Voice Amazing Race	\$450
 CMOS 27.3mm Ø 24.6 x 13.8mm 16:9	850	12 Stops	24, 25, 30 fps @ 1080 External Recorder	1920 x 1080	8 Bit MPEG2-4:2:2 MXF 64GB CF - 160 min	0.4 GB per Minute @ 24fps	3.2 lbs	11.4W	Incredible Low Light Performance Small Size C-Log Workflow Dual Pixel Auto Focus (FF Version Only)	The Green Inferno Blue Ruin La Vie d'Adèle	\$450
 Full Aperture 31.1mm Ø 24.9x18.7mm 4:3	500	15-16 Stops	1-60fps (No Scanner)	6K - 4K - 2K Uncompressed	16 Bit (Linear) 2P 22m12s 1000' 3P 14m48s 1000' 4P 11m06s 1000'	25 lbs 400' Load N/A 28 lbs 1000' Load			4:4:4 Color Sampling Established Workflow Wides: Available Latitude Proven Archival Value	12 Years a Slave King's Speech Cloud Atlas Silver Linings Playbook	\$1,000 w/Mags
 CMOS 31.7mm Ø 27.6 x 15.5mm	800	12 Stops	1000fps @ 4K 2000fps @ 2K 2000fps @ 1080	CineMag IV 4096 x 2304	12 Bit - RAW 64GB Internal RAM 4.7s @ 1000fps - 4K	750GB per Minute @ 1000fps	13 lbs	110W	High Resolution for Repositioning Sync Sound also works as 24fps Familiar User Interface Attachable On-Board Battery	Camera Newly Released Credits Coming Soon	\$5,500 w/(2) 2TB CineMags Camera Only (64GB)
 CMOS 30.1mm Ø 25.6 x 16mm	1250	10 Stops	1-1617 fps @ 2560x1440 1-2564 fps @ 1920x1080	2560 x 1440 Uncompressed RAW 1920 x 1080	12 Bit - RAW 32GB Internal RAM 4.5s @ 2500fps 512G CineMags 1m14s @ 2500fps	170 GB per Minute @ 1000fps	12 lbs	100W	Efficient Professional Workflow Industry Standard Low Light Performance Uncompressed RAW 4.4.4 Output	Godzilla (2014) ² Gangster Squad ² Iron Man 3 ² Rush ²	\$5,000 w/ CineMags (32GB) \$3,000 Camera Only (32GB)
 CMOS 22.6mm Ø 19.2 x 12mm	1100	10 Stops	1-1540 fps @ 1920x1080	1920x1080 Uncompressed RAW 1920 x 1080	12 Bit - RAW 12GB Internal RAM 3.2s @ 1000fps 240GB CineFlash 78s @ 1000fps	225 GB per Minute @ 1000fps	3 lbs	30W	Small Size Economical Low Cost RAW Memory	Too Cute ² Saturday Night Live ² Ralph Lauren Commercials	\$1,400 w/ CineFlash (60GB) Mags

¹Future ²Select Shots ³3D

Camera must be for sale and rent | Data based on 24fps and highest internal record | Sorted by Price

Figure 36. Camera Comparison Chart (www.nofilmschool.com)

But the competition is very strong, and other independent companies like REDONE are developing high resolution equipment in 4K and above, which are gaining important market shares. Below we can see a comparative table of existing camera equipment today.

3.2. Audiovisual Post-production

The traditional editing processes of professional film production involved a high-cost in time and resources, and obtaining the final edition or master was very cumbersome and impractical.

Likewise, the hybrid processes which have served as a transition from photochemical film to digital cinema during the last years present a complexity, as we see below, that does not facilitate the work. Sound, on the other hand, is necessary to register apart with the traditional procedures and then to synchronize it in post-production. The image recording is nowadays performed in DCI 4K and 8K systems, with much more competitive quality and recording costs in relation to the classic photochemical technology systems, and for that reason the digital production system is being forcefully imposed in all areas of film production.

/ Proceso largometraje 35 mm /

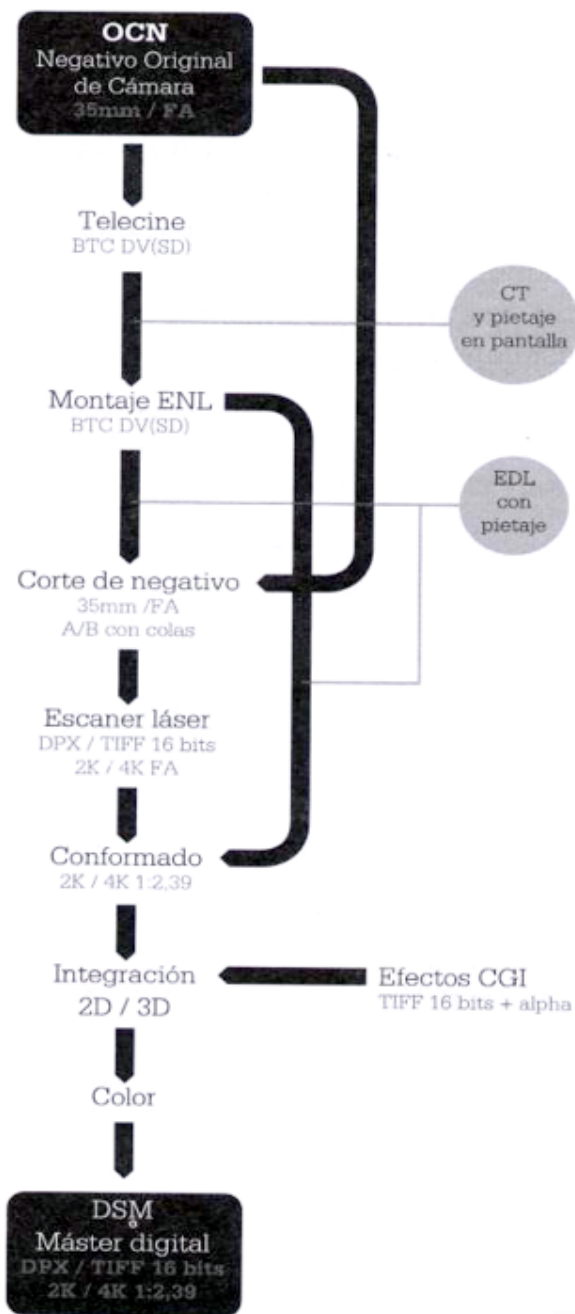

/ El sonido en el mundo audiovisual /

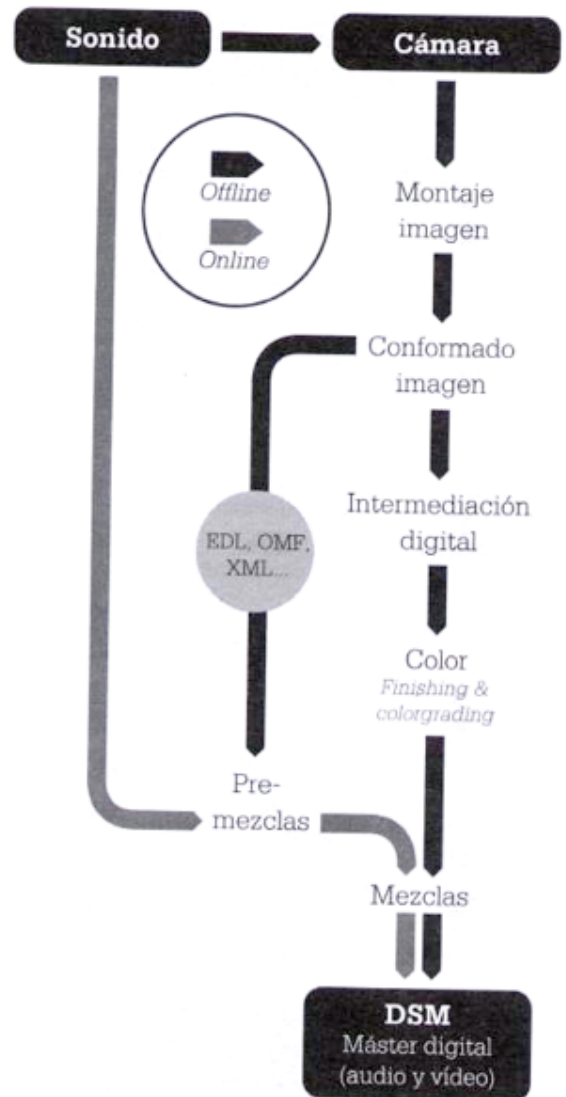

Figure 37. Hybrid Digital Photochemical Film Systems (Carrasco 2010)

At present, the full digital post-production workflow for film and video, in its simplest configuration, is the one we can see below exemplified for the work with cameras REDONE at 2K / 4K and FinalCut Software. First, a process of capture or ingestion of the data recorded in the camera is carried out to subsequently perform the editing, and then the colorimetric adjustment is done to finally obtain a master copy in the formats that are required.

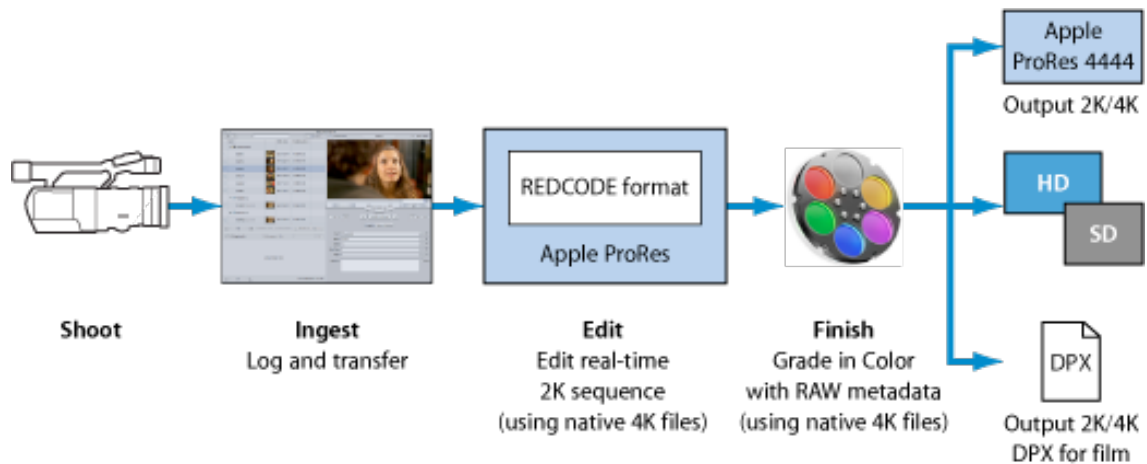

Figure 38. Post-production workflow (www.apple.com/es/final-cut-pro)

Current systems, in addition, allow group work and increase the productivity remarkably, facilitating also a multitude of operations for the edition and treatment of the image. The output of the editing system allows recording in multiple formats, including the classic videotape or other media distribution systems such as webcast or IPTV, depending on the required performance of the system and, of course, its cost.

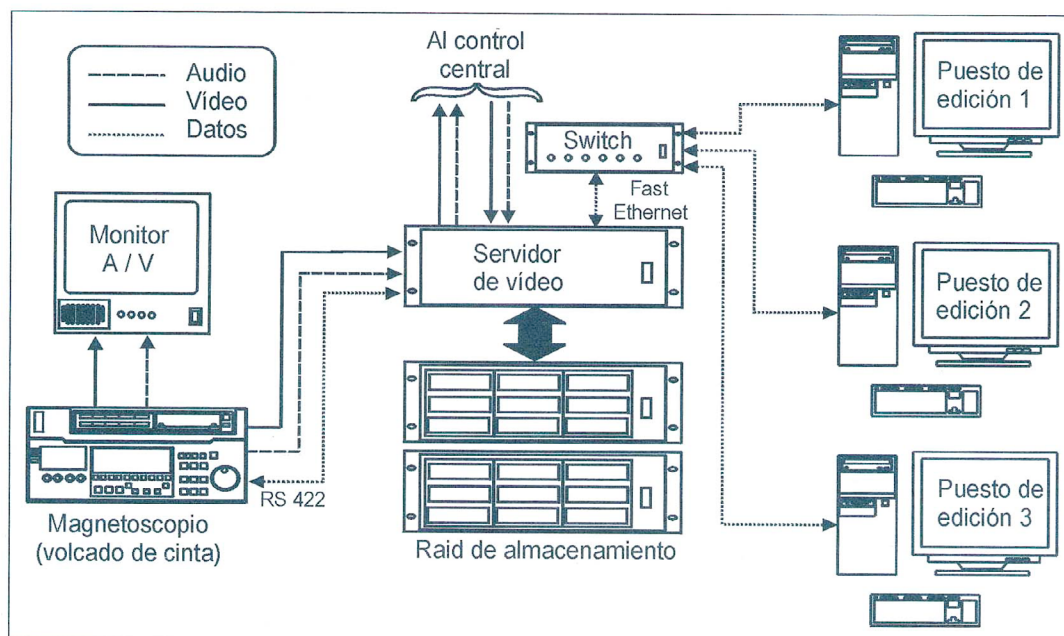

Figure 39. Server-based Digital System (Félix Molero 2006)

The most popular editing software is FinalCut which, together with Avid and, to a lesser extent, Premiere, dominate the professional video editing market. Any digital postproduction system works according to the work scheme with clips, as we see below.

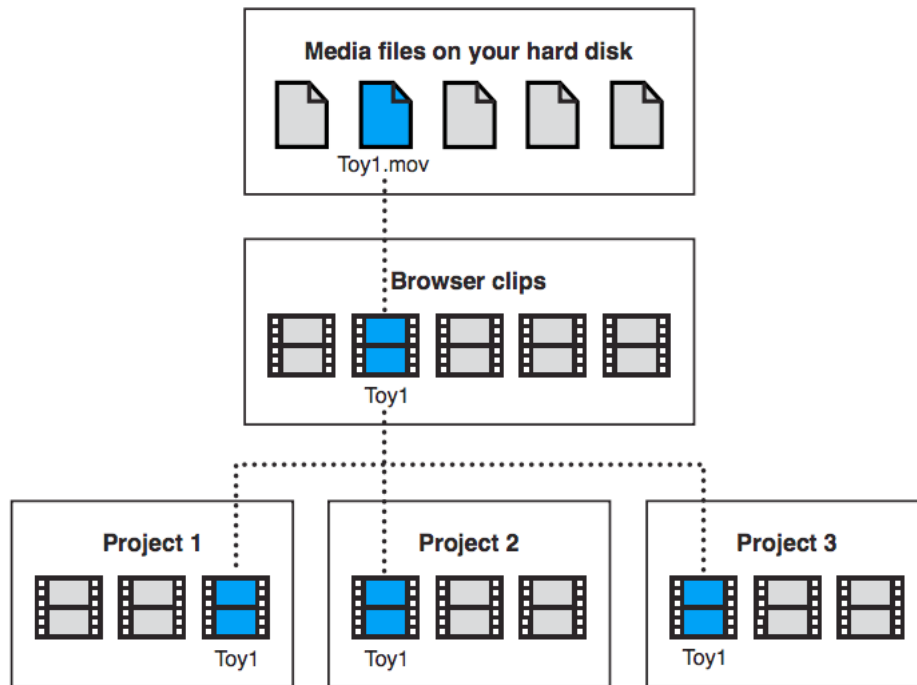

Figure 40. Clips-Mediafile Working System (www.apple.com/es/final-cut-pro)

And this is the interface of the program Final Cut X, similar to those other programs aforementioned, that can be configured with great flexibility depending on the type of editing to perform.



Figure 41. Final Cut X Interface (www.apple.com/es/final-cut-pro)

In any postproduction workflow, color correction is often one of the last steps to finish an edited program. There are numerous reasons to correct color:

- To ensure that the key elements of your program, such as skin tones, look the way they should.
- To balance all the shoots of a scene to match.
- To correct color balance and exposure errors.
- To achieve a special appearance, such as making the scenes colder or warmer.
- To create contrast or special effects by manipulating colors and exposure.

The process can be done in a more or less automated or manual way, with color correction tools that provide precise control over the appearance of each clip of the project, allowing to adjust the color balance, shadow levels, tone level media and the levels of clear areas of each of the clips.

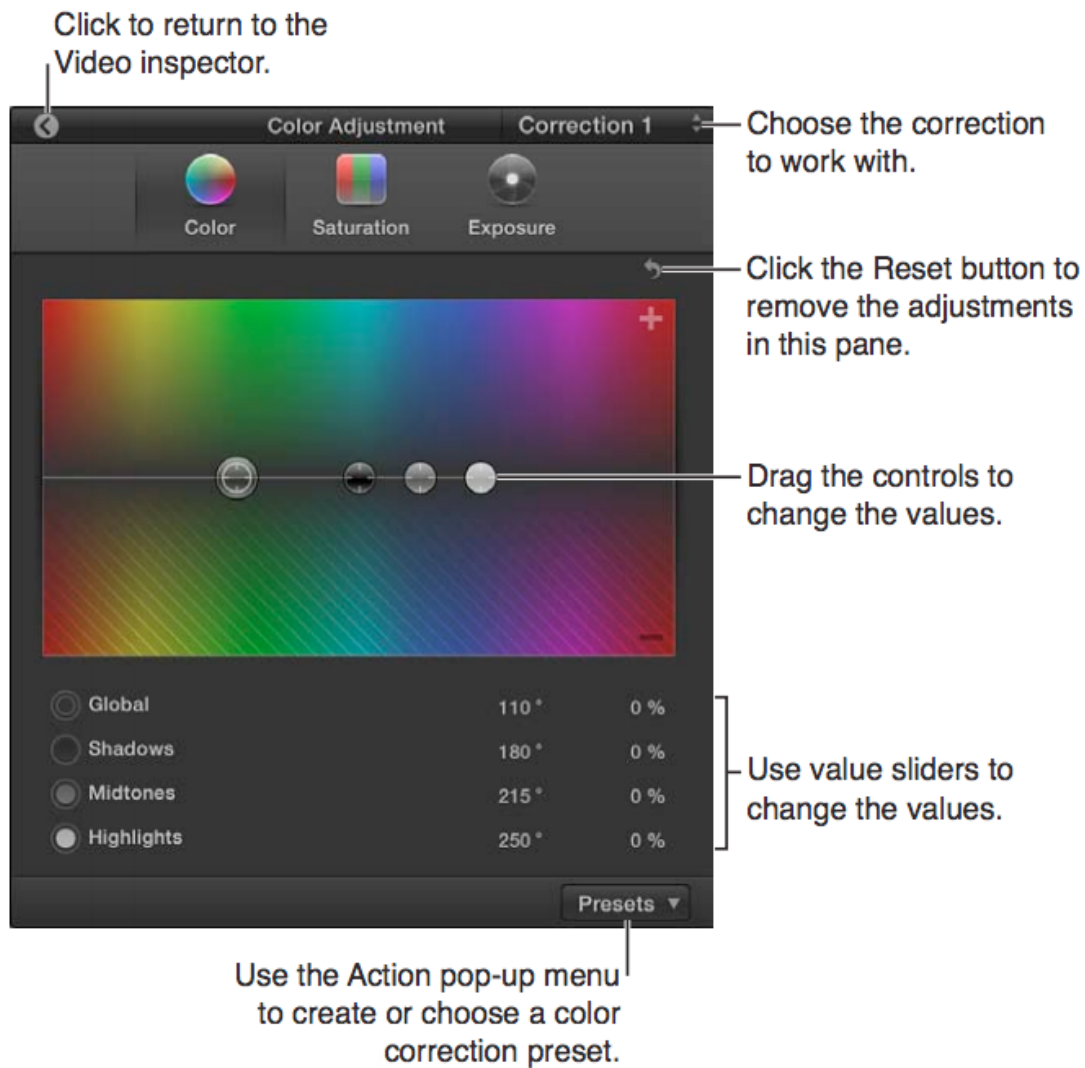

Figure 42. Color (www.apple.com/es/final-cut-pro)

Finally, once the edition is finished and the color of the project is the intended one, there is nothing left but to choose the device to which it will be distributed to generate the file adapted to each media or distribution channel.

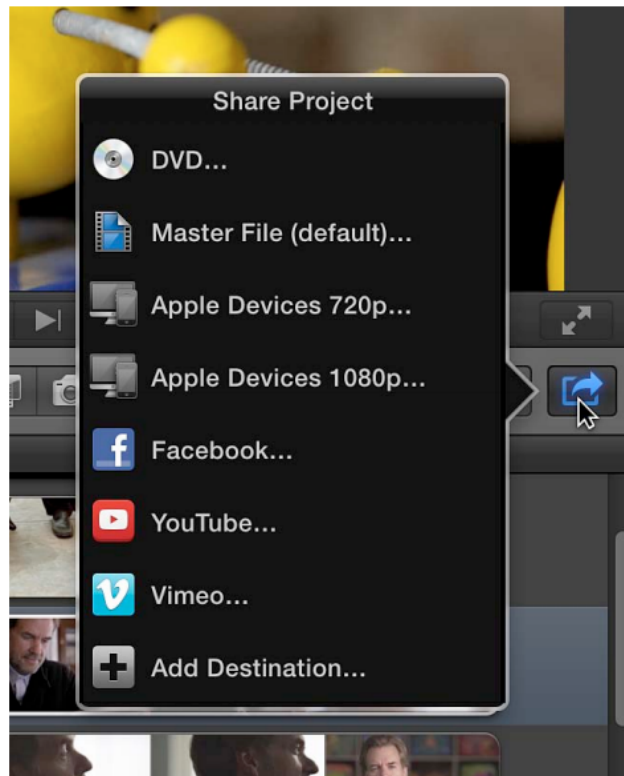

Figure 43. Common Distribution Formats in Final Cut X (www.apple.com/es/final-cut-pro)

3.3. TV Production Studio

As we will see below, the audiovisual studio production systems allow the integral treatment of the digital signal from capture to emission, establishing functional systems based on computer equipment which is interconnected through data networks and servers for storage and archiving. In this manner, it facilitates working groups and fast accessibility to processes and files and makes efficient use of the multiple possibilities of audiovisual treatment offered by digital environments, with significant increases in productivity and reduction of costs.

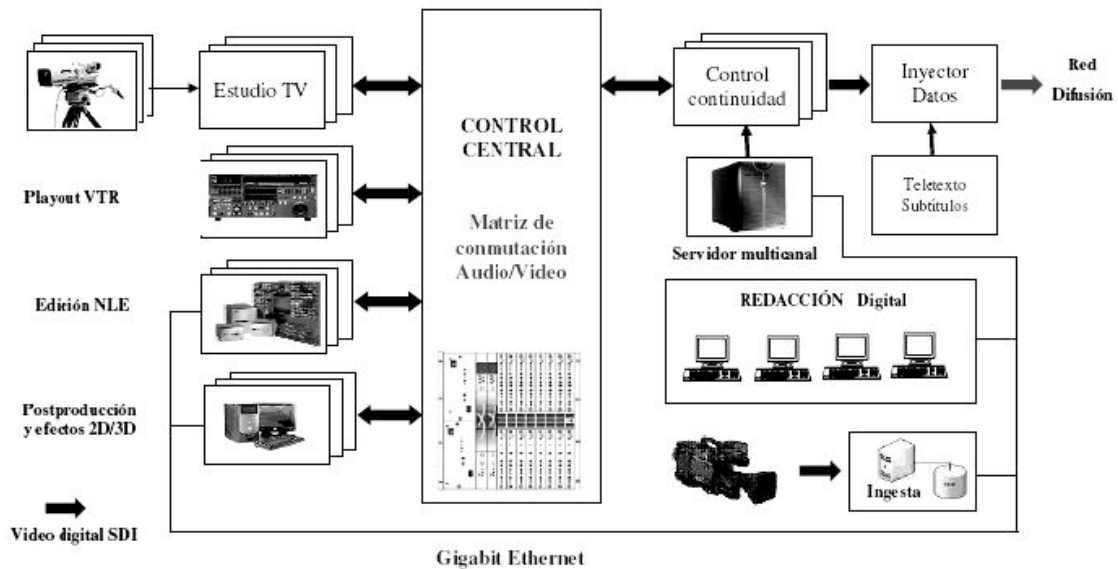

Figure 44. Digital TV Production Center (Millerson 2009)

The equipment for the production of programs on set in a television center, as we can observe in the following scheme, can be divided into four types: the equipment used for the capture of the image, the one necessary to adapt the lighting conditions to make the capture of the image possible; the equipment used for sound recording, and finally, the interconnection and communication equipment system.



Figura 19.6. Configuración típica de un plató de televisión.

Figure 45. TV set equipment (Félix Molero 2006)

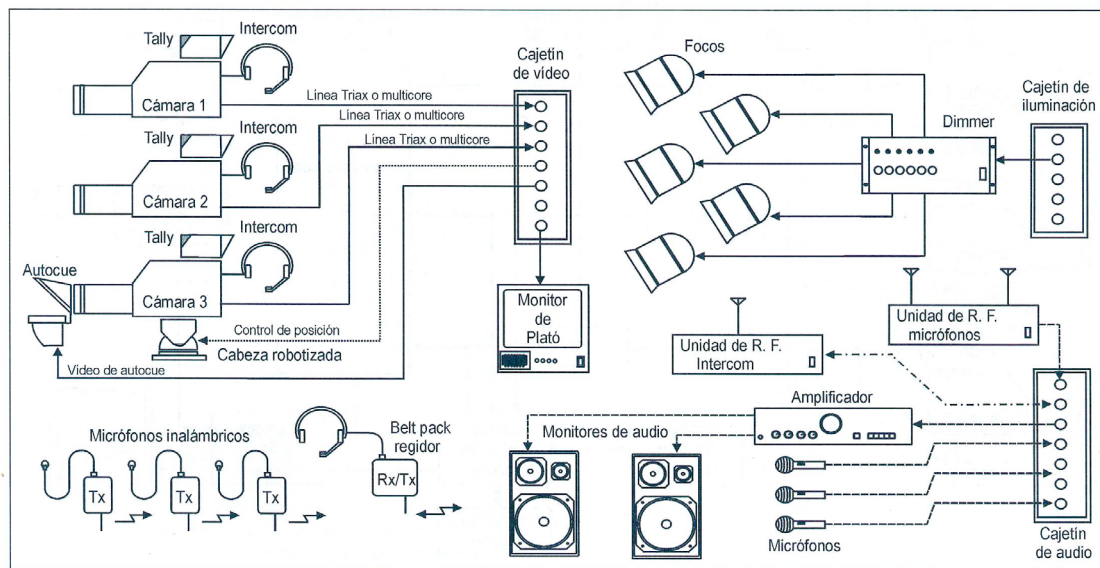

Figure 46. TV Set Labcom-UJI and studio production equipments (Labcom UJI)

As we can see below, within the specific section of the production control for the image control the sources of imaging capture get to a distributor called patch panel, either from signals directly captured on set from the CCU (Camera Control Unit), the equipment used for the basic remote operation and control of the video signal of each one of the cameras that operate on the set, or sent from the videorecorders in which videotapes with previously registered images have been inserted. The signals are monitored, both for the visualization of the image in conventional monitors as in its representation as a video signal in the oscilloscope and vector-scope, specific equipment for the measurement and technical control of the quality of the signal. The image sources are directed to a switching matrix, the mixer, to obtain as their output a single video signal resulting from the selection and/or conjunction of one or several of the input signals.

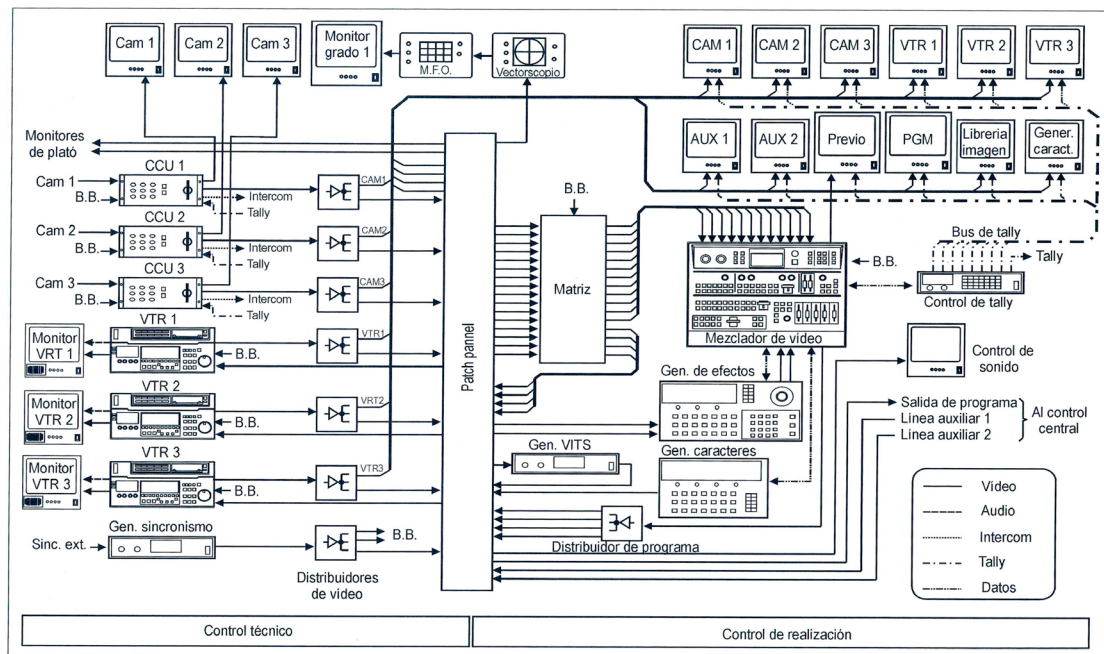

Figure 47. Video Production Control (Félix Molero 2006)



Figure 48. Equipments for TV Control Production (Labcom UJI)

As we see in a very schematic way, in an image mixer we find different video inputs that can be mixed or addressed individually toward the output, also called program signal which indicates, if it is a camera, its activation and on-air programming with a return signal called tally. To any video input, whether camera or prerecorded videotape, you can insert text and graphics and special effects through key processes or DSK, which allow parts of the image to be replaced by another, depending on their similarity on chromatic or light features. Sometimes a specific external equipment is used for this, although more and more frequently all the treatment functions are integrated in computer environments that include multiple mixing options and effects.

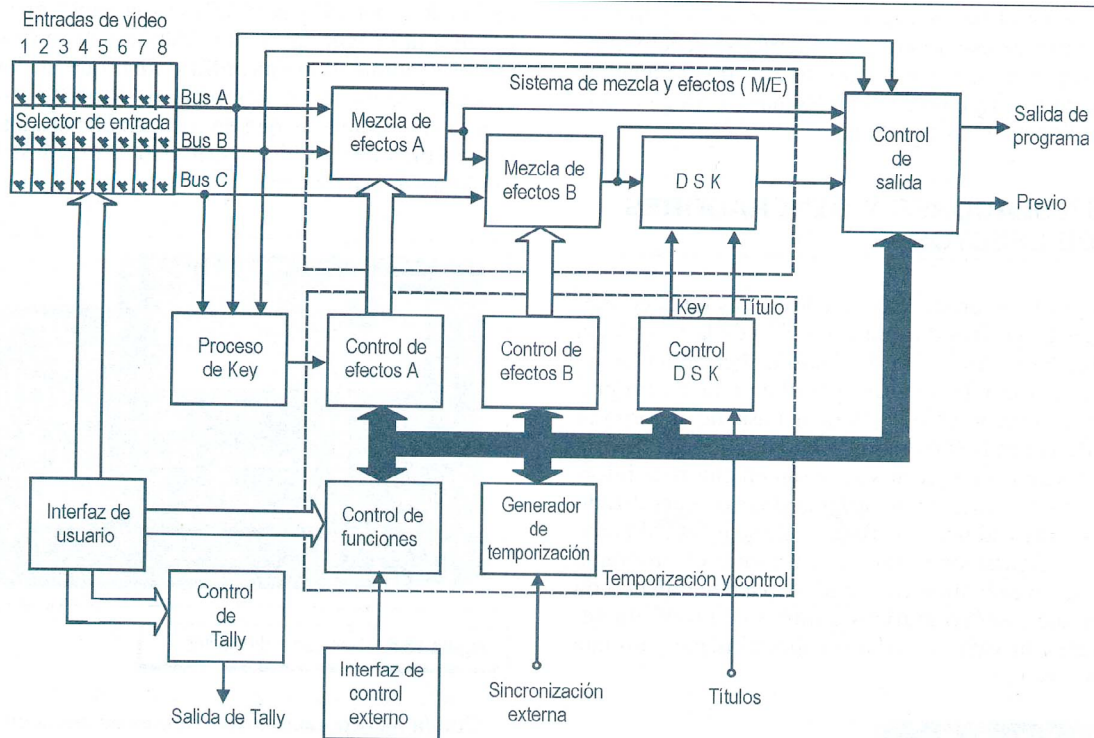

Figure 49. TV Image Mixer (Félix Molero 2006)

For sound control and processing, similarly, each of the different sources is directed to a mixer to obtain a single program audio signal after processing, sometimes using auxiliary processor equipment, although increasingly they are usually integrated into digital mixing tables.



Figura 19.12. Esquema de bloques de un control de producción (audio).

Figure 50. Audio Production Studio (Félix Molero 2006)

In a mixer such as we can find nowadays, and in any digital production system, the different input source signals that are monitored and mixed converge to obtain a program output, making use of high-speed and reliable connections, such as firewire as we will see in the example below or others, which allow efficient work with any type of input source and digital signal.

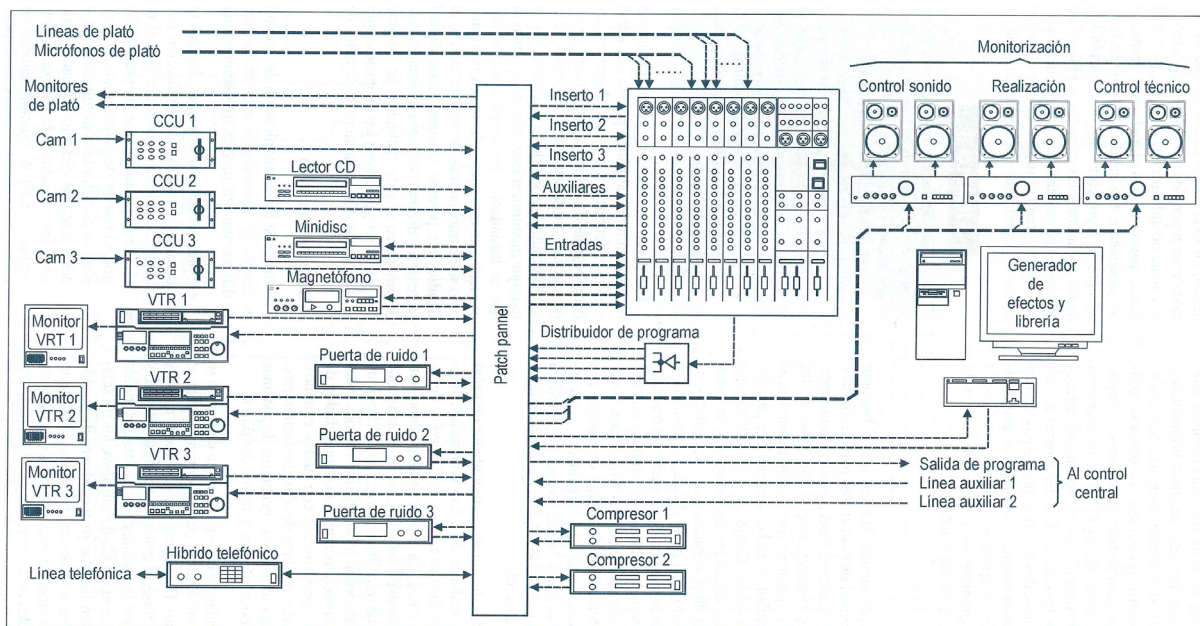
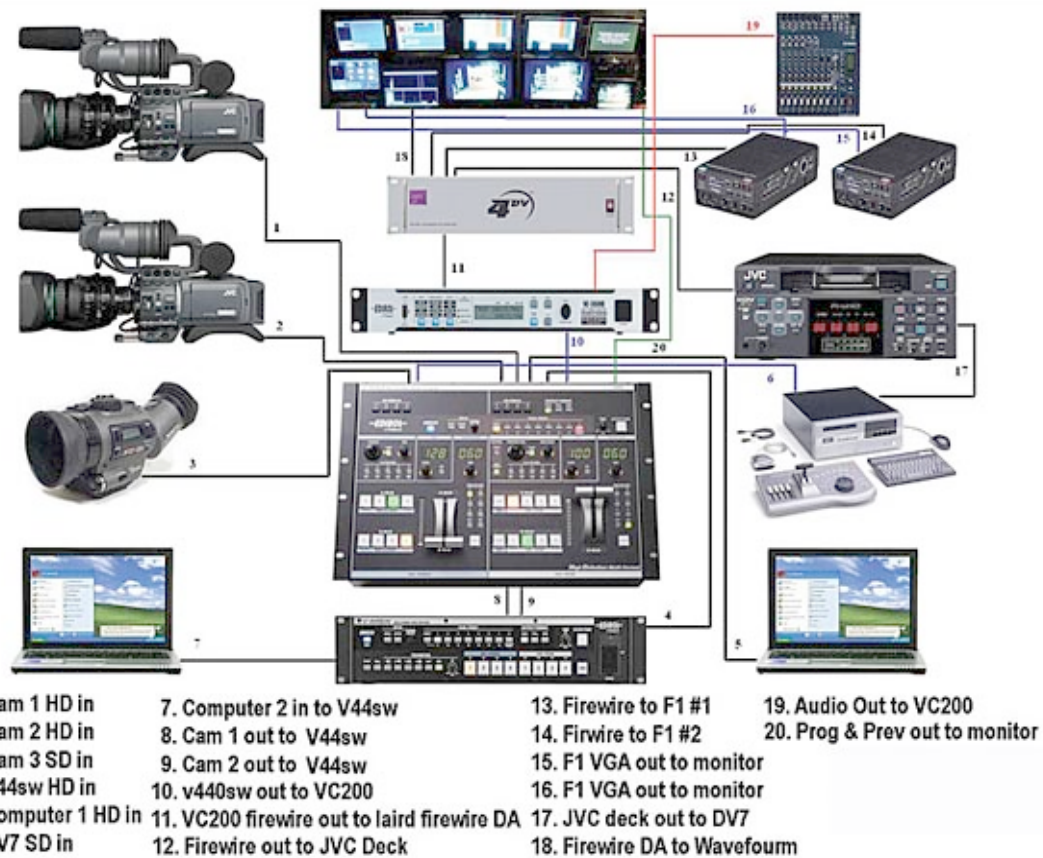

Figure 51. Digital Image Production System (www.sony.com)

Integrated systems for mixing and processing images in computer media allow managing a multitude of sources, as well as introducing titles, special effects and image quality control with the same software that is increasingly simplifying their use and improving the effectiveness.

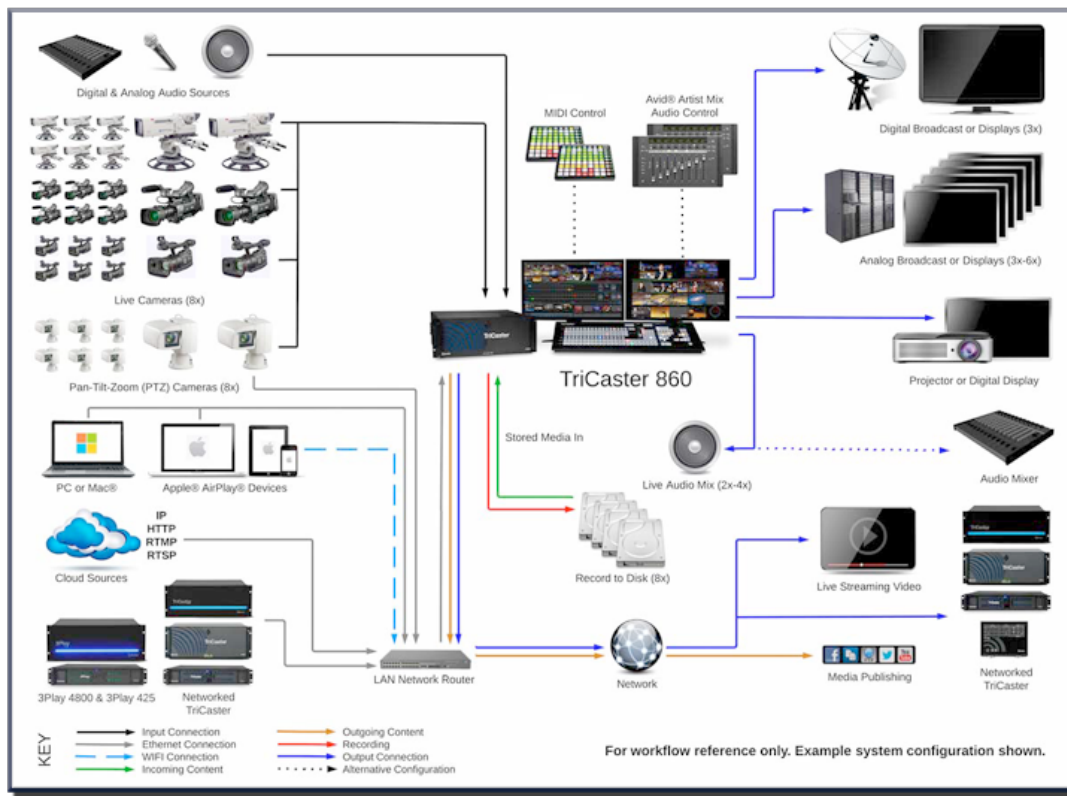

Figure 52. Mixing and processing of digital image (www.es.newtek.com/tricaster/)

In a similar way, the control of the studio is being computerized, especially for the creation of virtual scenographies that allow the design of highly attractive environments using synthesized images easily developed in 3D graphic environments. The virtual scenography systems can even be complemented with robotic equipment for the control of cameras that allow their automated or manual operation completely at a distance, nowadays especially used in news programs.

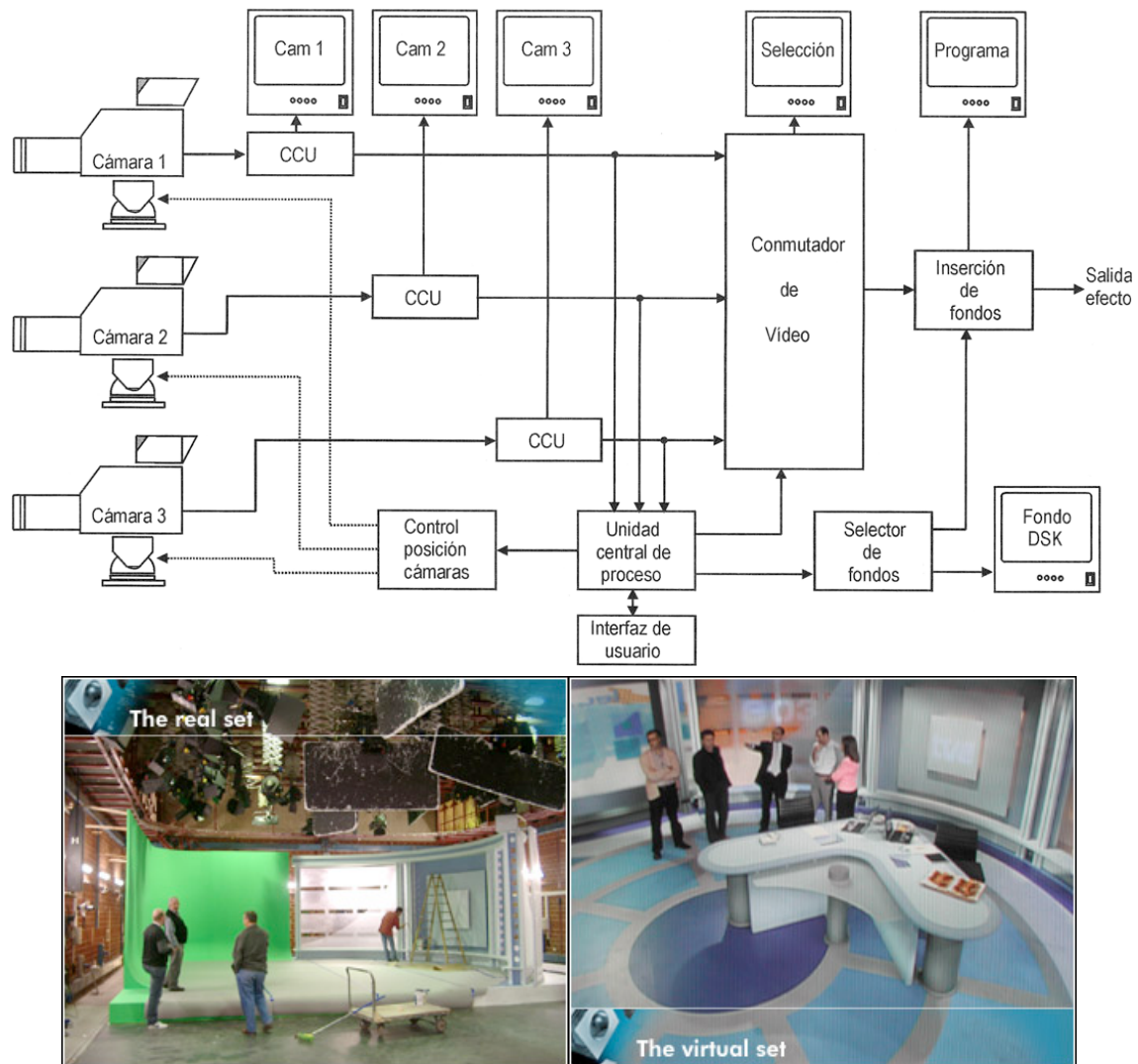

Figure 53. Virtual Set (www.brainstorm3d.com)

In television production centers, one of the most critical aspects is the technical adaptation and synchronization of signals from different sources, and it is common to find a centralized technical control in which the signals coming from the TV production center are integrated and redistributed. The TV control can use several sets and receive different signals, such as those received from external links, also serves to perform conversions between formats and copies. In addition, there is usually a specific section dedicated to the emission and reception of various

signals, including those assigned to the DTT broadcast, which we will see in the following section.

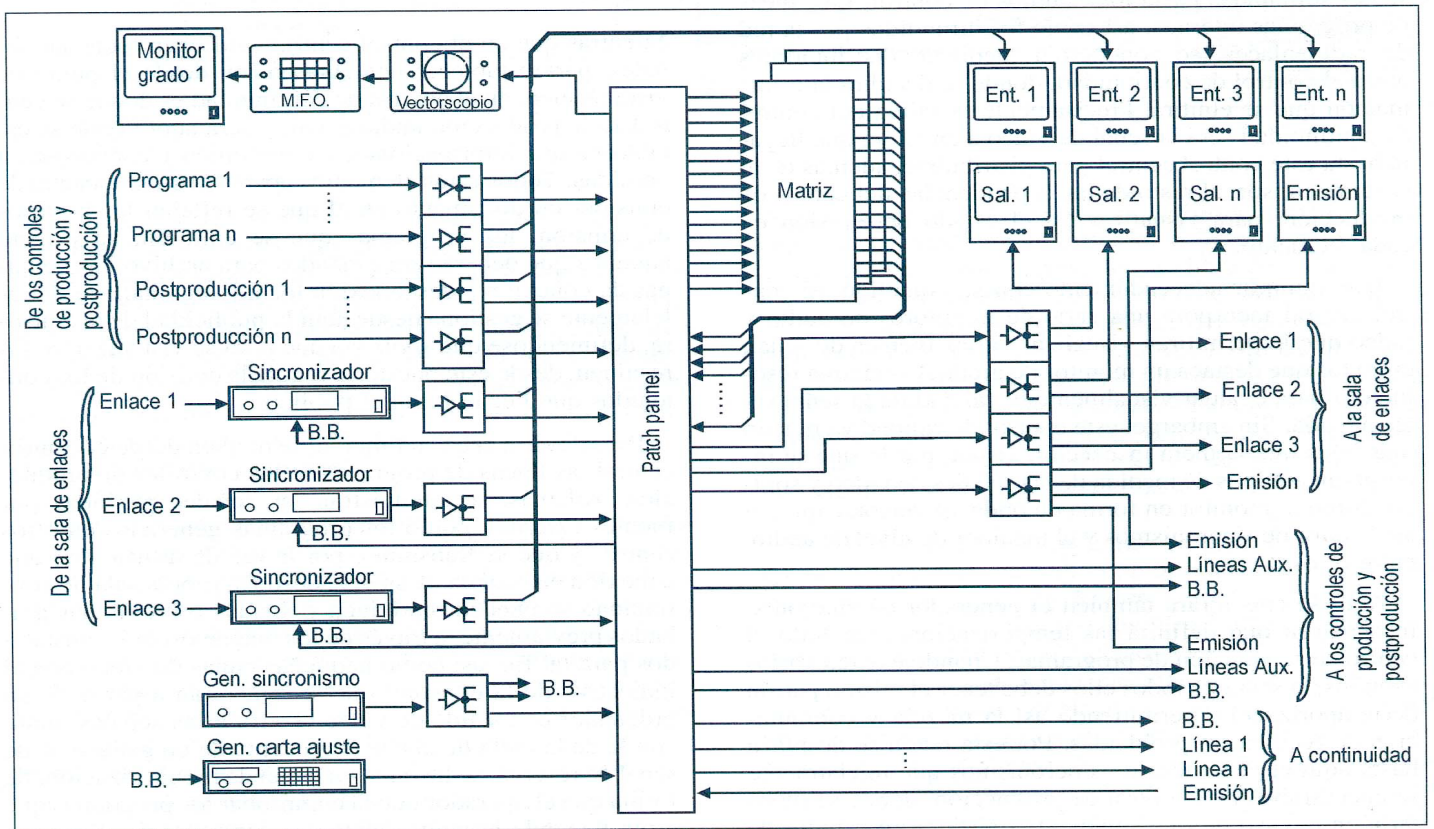

Figure 54. Technical Control (Félix Molero, 2006)

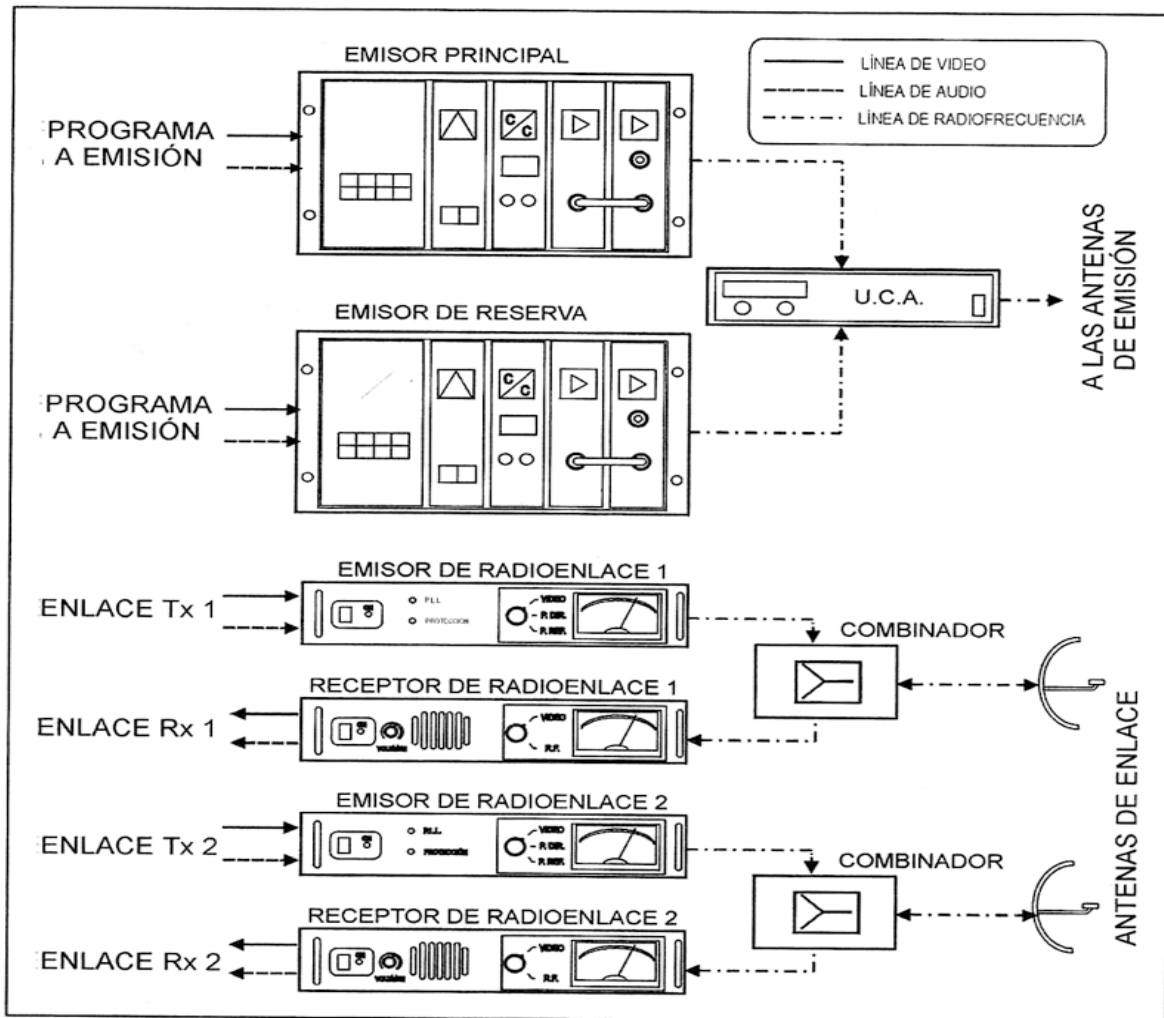

Figure 55. TV Links (Félix Molero, 2006)

Television broadcasting is carried out from the emissions control section, which has computer systems that allow to place sources of all types of provenances and features in the flow of emission.

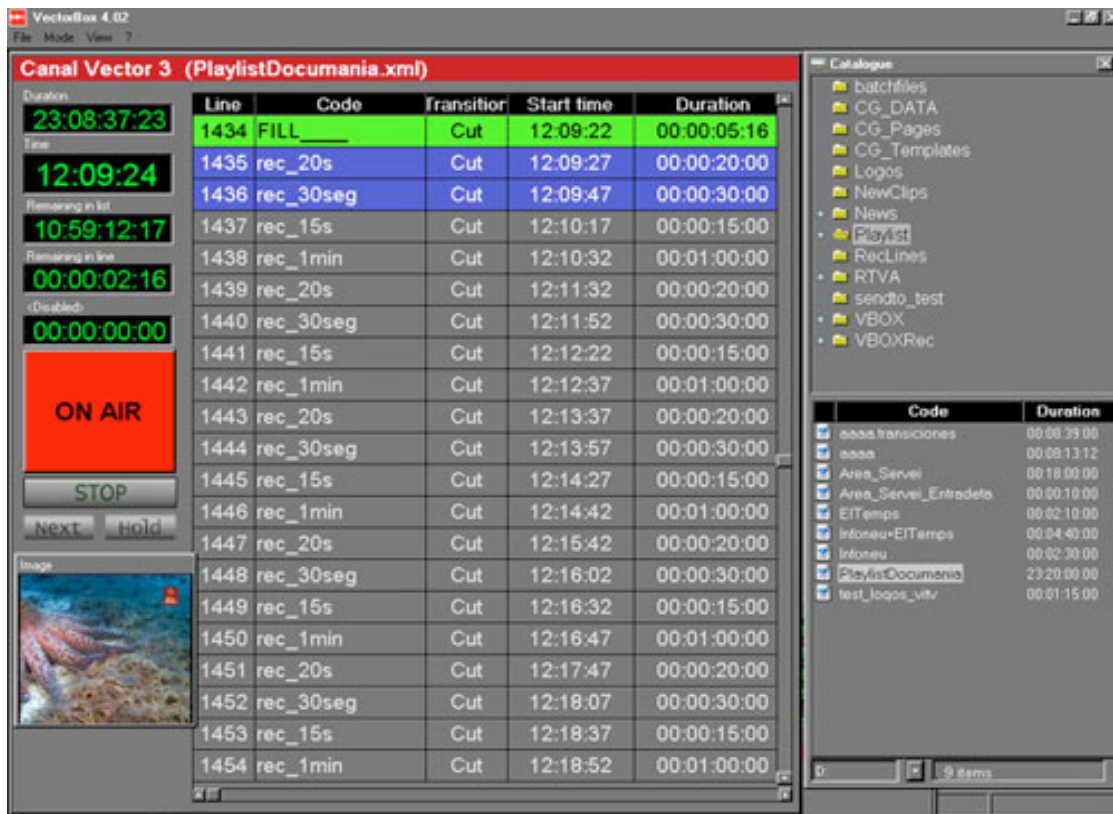

Figure 56 Automatic Playout - VectorBox (www.vector3.tv)

The link section contains, on the one hand, the transmitters, including a reservation to avoid possible cuts in the television broadcast, and, on the other hand, various receivers and emitters of radio link signals for connections to mobile units or the reception of various signals. A mobile unit, as we see below, is the synthesis of a control section with capacity for the production and autonomous management of audiovisual signals that are sent to the central studios by using diverse networks and transmission systems.

Figura 19.20. Unidad móvil.

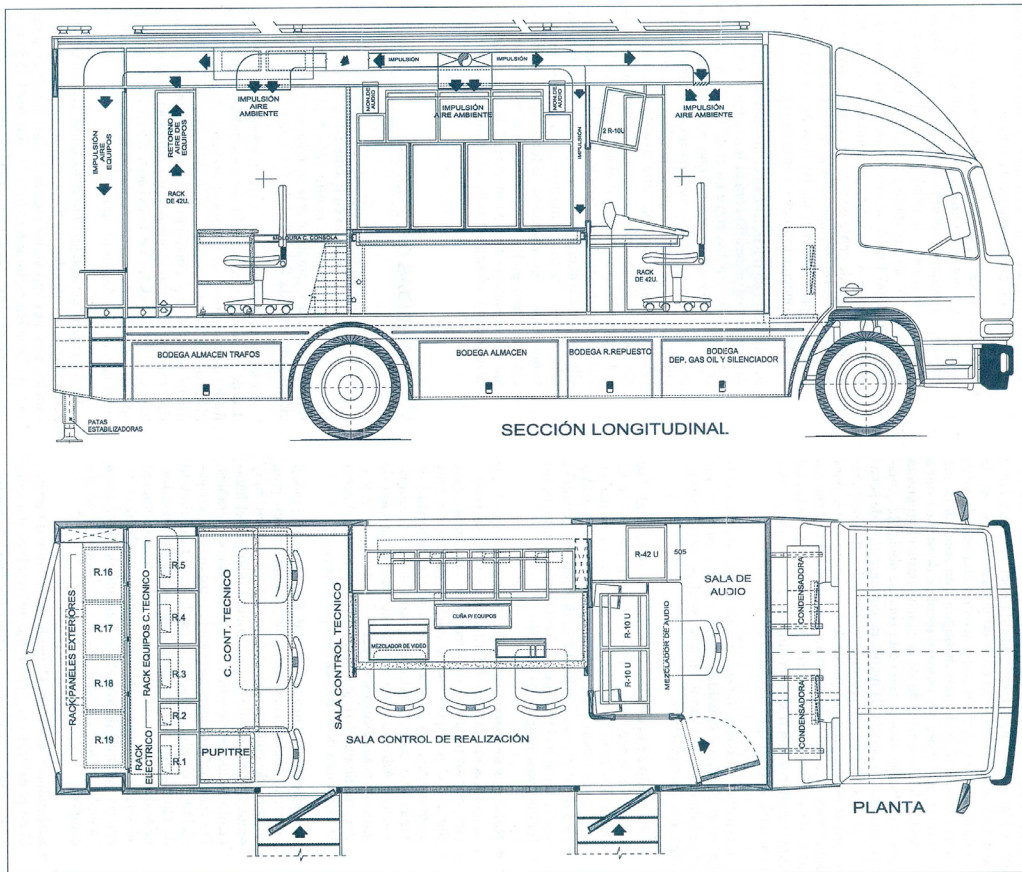

Figure 57. Mobile TV Unit (www.live-production.tv)

In short, the different production areas of television studios are trying to integrate as much as possible to automate all the process in order to streamline the workflow. As we will see below, audiovisual distribution systems are also being fully digitized, thus enabling significant increases in productivity and improving the final quality of audiovisual products but, above all, significantly reducing costs and, therefore, they increase the profitability of the audiovisual industry as a whole.

4. Audiovisual Content Distribution Systems

Summary

This last section of the textbook examines the new forms of audiovisual distribution, as well the norms of digital television broadcasting and the new trends in the transmission of audiovisual content using communication networks. Finally, we analyze the characteristics of the current equipment for the monitoring of video and television and for the digital cinematographic projection.

4.1. Digital Cinema Distribution. The DCI system

Audiovisual contents distribution has evolved a lot over the last few decades as a result of new forms of digital production, which provide a digital master, named DSM-Digital Source Master, which can easily be transcoded to any distribution format. Thus, as we see below, audiovisual content, whether from a traditional film copy or a digital copy (DCI-Digital Cinema Initiative), can be distributed in different formats, in what is named multicast distribution, depending on whether they are intended for a broadcast medium or others such as digital television, home viewing or internet television. For this, the audiovisual contents are compressed with the established codecs, according to the diffusion standards proper to each distribution medium.

/ DSM y distribución multicast /

Con transfer a 35 mm

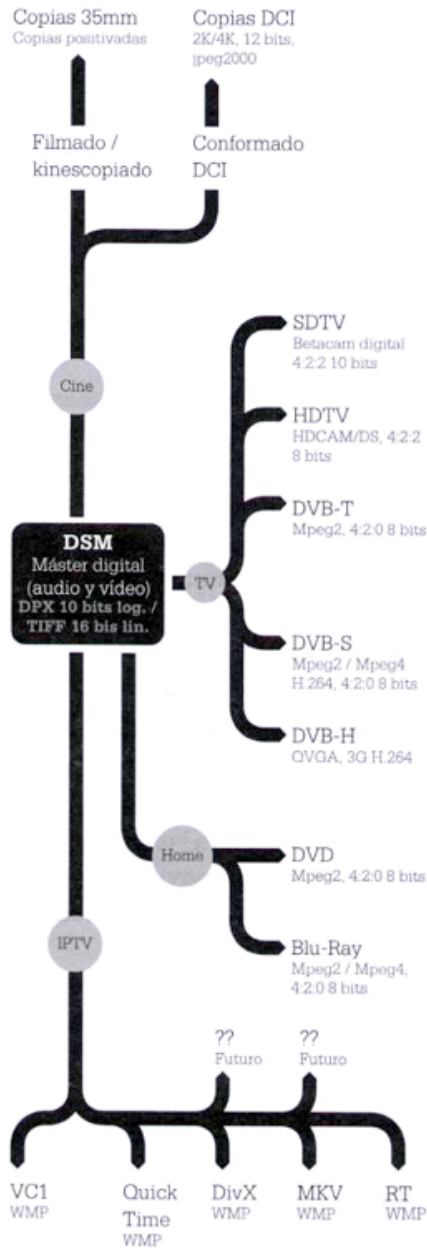

/ Estándares de compresión MPEG /



Figura 58. Multicast Content Distribution (Carrasco, 2010)

Today, as mentioned above, the rapid implementation of the digital cinematography system is taking place, replacing the supports and production procedures which were typical for the traditional photochemical technology.

As we already have commented for other audiovisual fields, the proposals for the standardization of digital cinematography have initiated from the content production and distribution industry itself. Grouped around the so-called Digital Cine-

matography Initiative (DCI), companies such as Sony, Walt Disney, MGM, Warner, Paramount, Fox and Universal Studios began to work on the development of a standard format for digital cinema by 2002. As a result the successive versions of the DCI standard have been implemented, now widely used in the film industry for the distribution of audiovisual content.

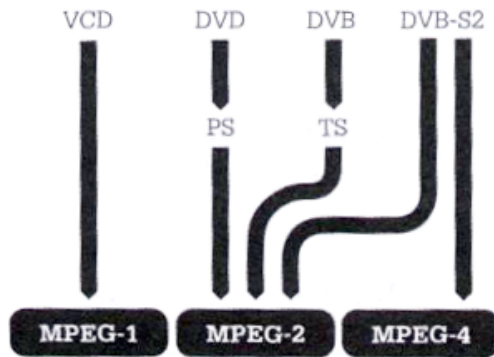
The digital cinema distribution system, as it has now been established following the DCI standards, can be schematized as we see below.

/ Flujo de trabajo del cine digital /

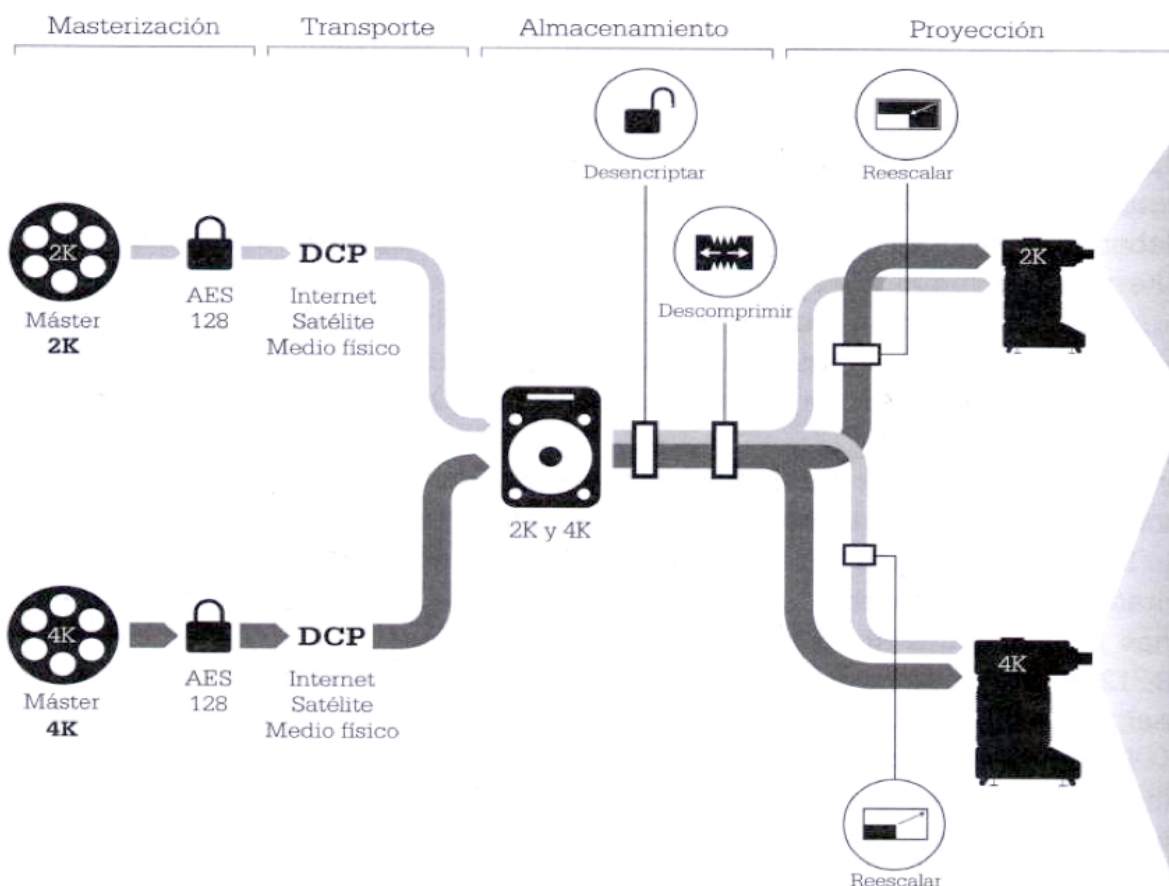

Figure 59. Cinematographic Contents Distribution (Carrasco, 2010)

In this sense, the DCI specifications establish the resolution, color depth, aspect ratio, cadence and compression system that determine an optimal level of quality as follows:

- Scanning a 35mm negative, which has 150 lines of resolution x millimeter and a color depth equivalent to 13 bits per channel, needs to use a minimum resolution of 2K and 8bit, although it is preferable that it is 4K or higher.

- The DCI system determines how the original DSM (Digital Source Master) file has to be converted into a Digital Cinema Master Digital (DCMD) file which, following the standard, must be uncompressed. Afterwards, that DCMD will be converted into a DCP (Digital Cinema Package) with and from which it is possible to distribute the suitable copies for projection in digital cinemas.
- DCI determines the following 4K resolutions and aspect ratios: 2.39 (4096 x 1.716) / 1.85 (3.996 x 2.160) and 2K: 2.39 (2.048 x 858) / 1.85 (1.988 x 1080).
- The cadence of the image is set to 24fps, in 2K the possibility of 48 also exists.
- The sound is recorded at a maximum of 16 channels and with a sampling rate of 48 or 96 kb/s.
- The DCI standard establishes intraframe compression based on JPEG2000 for the DCP file.
- The maximum data volume is set to 1,302,083 bytes/frame, so that 3 hours take approximately 200TBytes.
- In the codification of the copies for distribution and projection a security system is established through KDM (Key Delivery Manager) encryption.

As a result, and as we will see below, the current digital cinematography system makes efficient use of production technologies and establishes strategies for the distribution of audiovisual contents that facilitate their availability for projection with optimal quality standards.

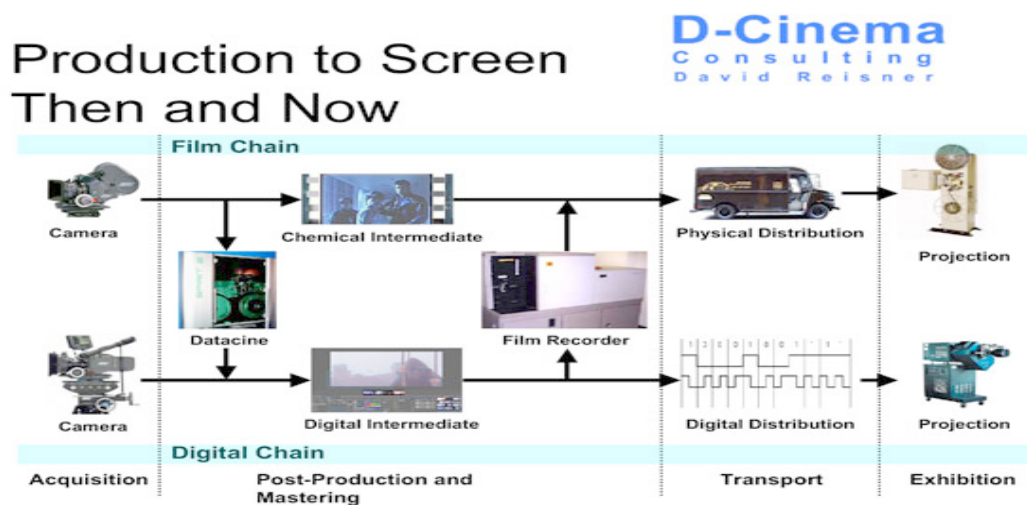

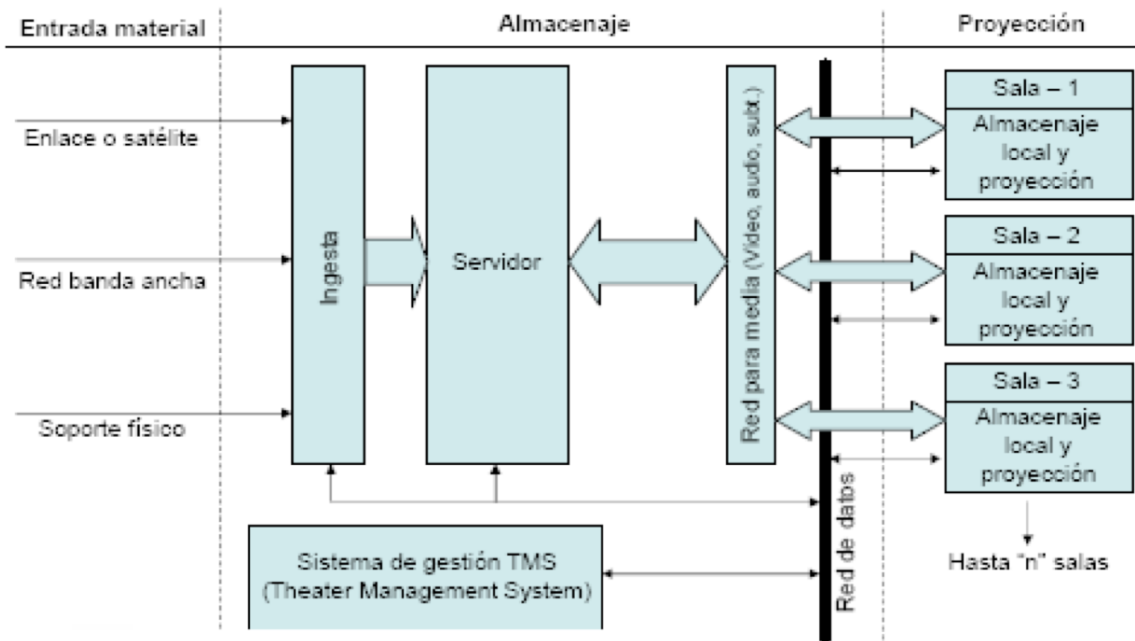
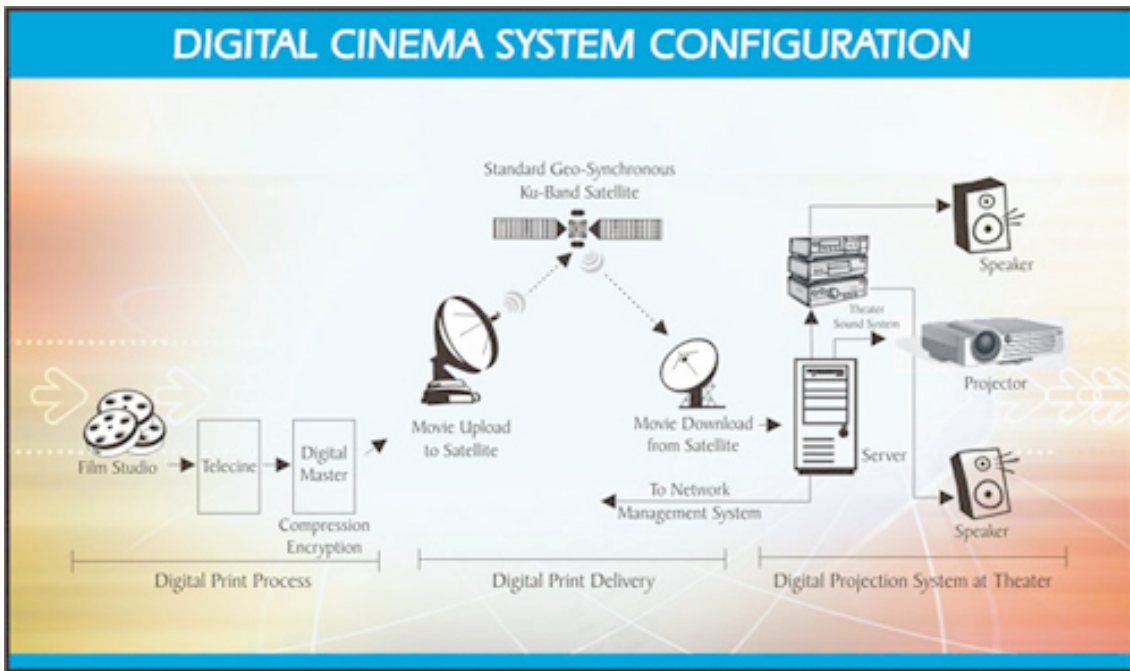

Figure 60. Digital Cinema Distribution System (www.redone.com y www.dvb.org)

The trend, as we have been insisting, is to increase the efficiency of the entire system of content production and distribution to reach the maximum productivity. To this end, high-capacity servers and existing digital signal transport networks are used to facilitate the availability of cinematic quality content on the screens of the projection rooms, in short, to increase audiences and the profitability of the film industry.

4.2. Digital Television Systems. Transmission Standards

As we have shown, television is nothing more than a transmission system that attends to certain norms for the conformation of the video signal and that, until recent times, has been realized using analog systems like PAL, NTSC or SECAM, already replaced by the new digital television transmission systems.

Broadcasting is still carried out mainly by electromagnetic waves and using the radio spectrum, which, as we will see below, have reserved certain frequency ranges for television, specifically in the band that goes from 30Mhz to 3Ghz.

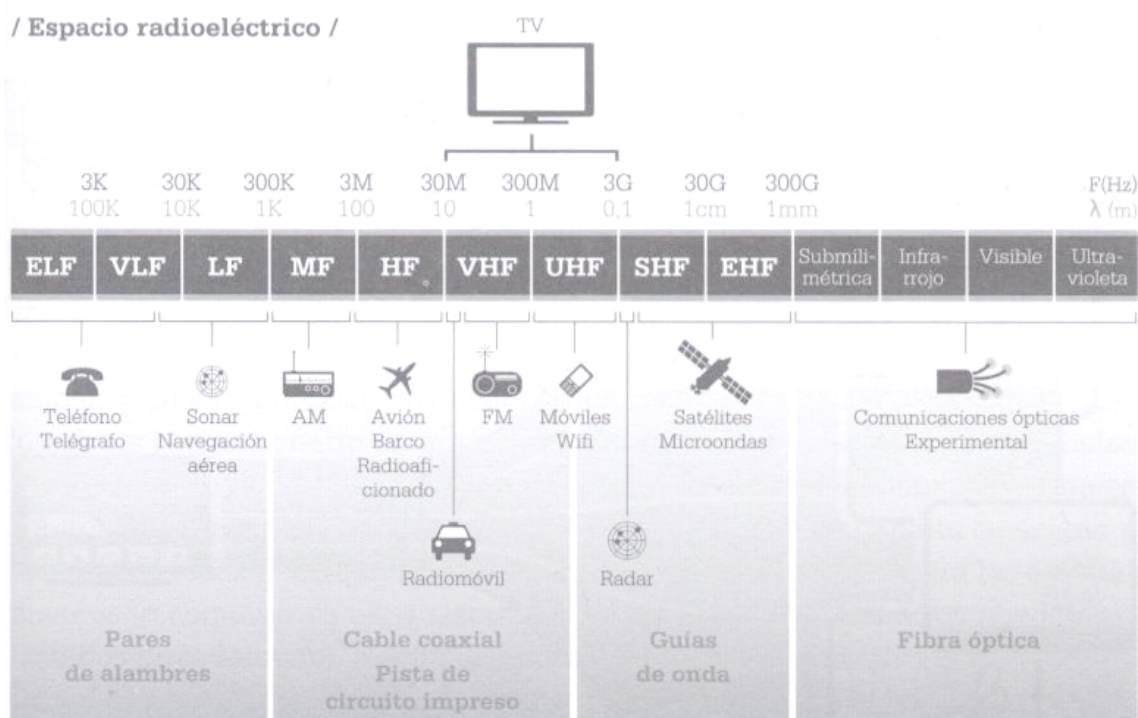

Figure 61. Frequency Band for TV broadcasting (Félix Molero 2006)

However, unlike it was done a few years ago, now the transmission is coded from an digital signal and the carrier is modulated from a signal that has only two possible values, 0 and 1. Transmission is still done similarly to the analog way, as will be seen below, but the information contained in the transmitted signal is digitally encoded.

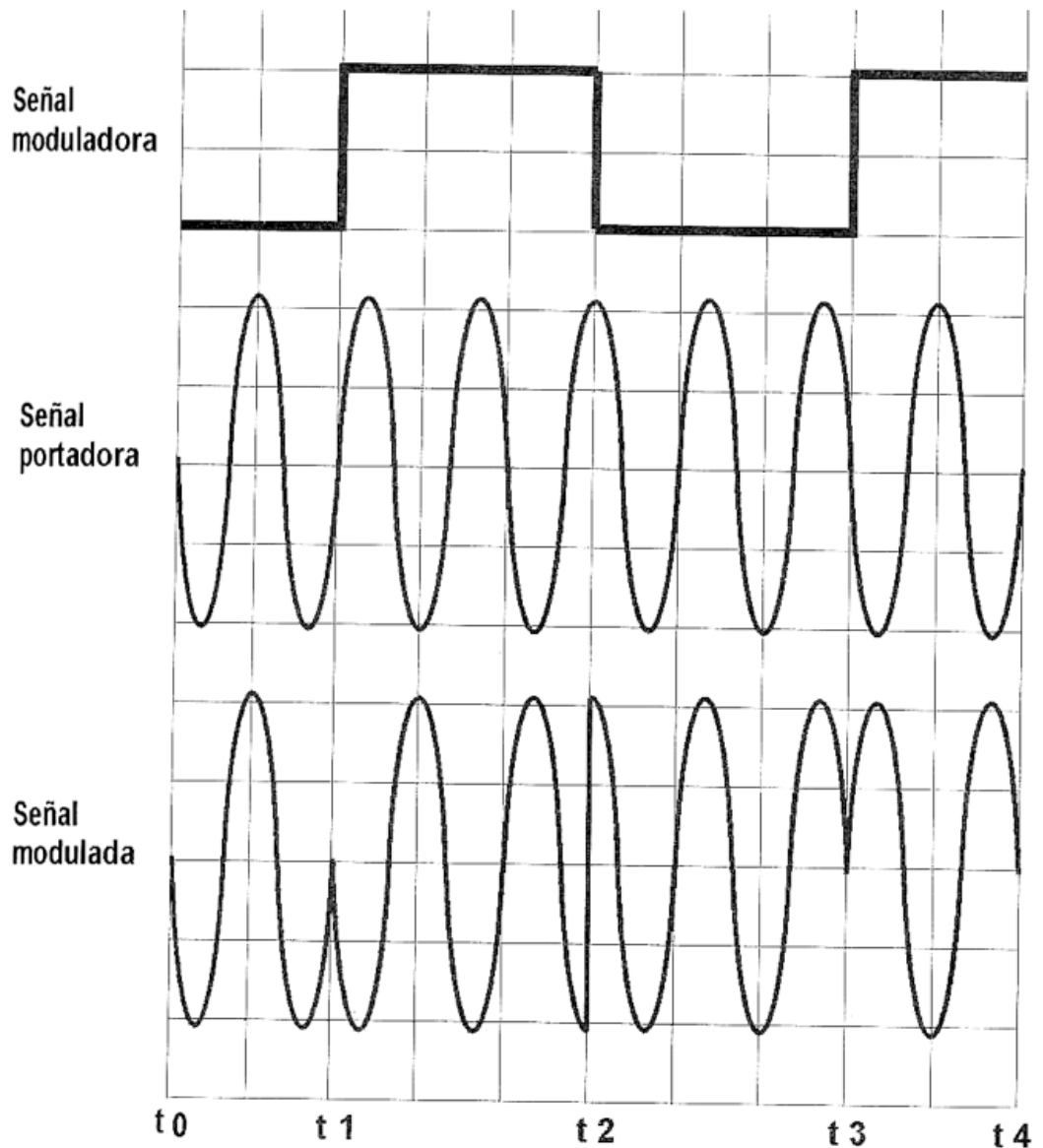

Figure 62. Digital Transmission (Félix Molero 2006)

Similarly as we have been commenting for the film distribution, in recent times also the television distribution has completed the transition from analog to digital, and for that reason we can consider that the sector of the distribution of contents is now entirely digitized.

In this sense, the digital television system can be understood, as we will show in the following diagram, as a set of broadcasting modalities that includes the use of satellites, terrestrial, cable and telecommunication networks. For each of them, specific processes of encoding and compression of the signal are carried out following the specifications of the standards corresponding to each distribution system.

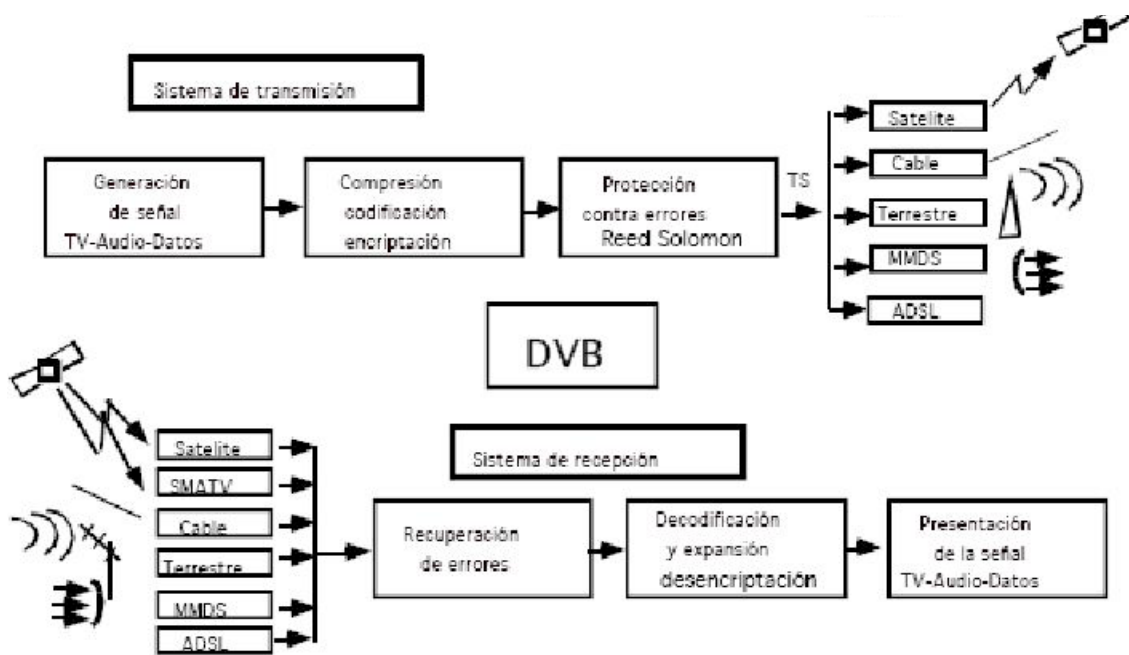

Figure 63. Digital Video Broadcasting Multicast Distribution (www.dvb.org)

For Digital Terrestrial Television (DTT), the DVB Group developed the DVB-T or TDT standard, which uses the OFDM (Orthogonal Frequency Division Multiplexing) transmission and establishes channels with a bandwidth of 8Mhz and a data stream of 16 Mb/sg, and sets color at 4: 2: 2 encoding type with MPEG2 compression. With this parameters it is possible to broadcast up to 4 programs in a single channel with optimum quality, thus multiplying significantly the offer of digital television channels in comparison to those used until recently for analog television.

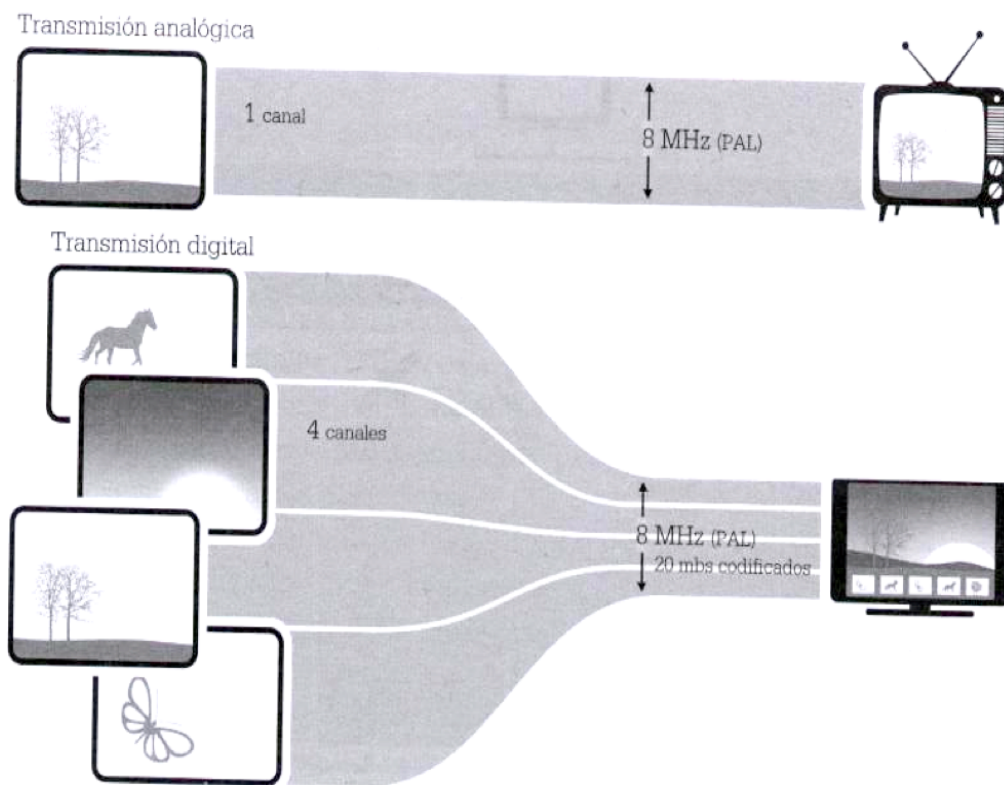

Figure 64. DTT Channel Programs Distribution (Carrasco 2010)

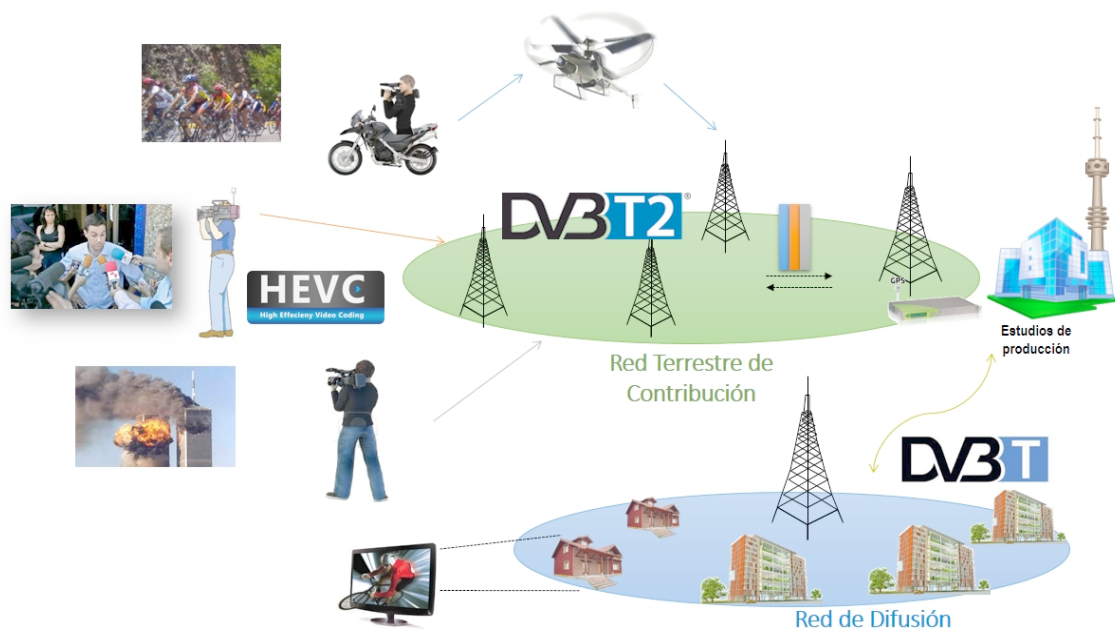

Figure 65. DTT Broadcast System (www.dvb.org)

The DVB-S standard, designed for Digital Satellite Television, uses QPSK (Quadrature Phase Shift Key) modulation, and 36Mhz bandwidth with a data rate of 39 Mb/sg, allowing to insert up to 10 programs in the same frequency of emission. Likewise, the DVB-C standard for cable television transmission, with QAM (Quadrature Amplitude Modulation) modulation, uses a bandwidth of 8Mhz, a data flow of 32 Mb/sg and allows up to 8 programs per channel.

There are also specific rules, which we will see below, for broadcasting with microwaves and for transmission via mobile telephony and the internet, although one of the most significant improvements introduced by digital technology in television production and distribution centers is the possibility of multiplatform diffusion, with which it is possible to easily access the different ways of commercialization, so business opportunities are significantly extended.

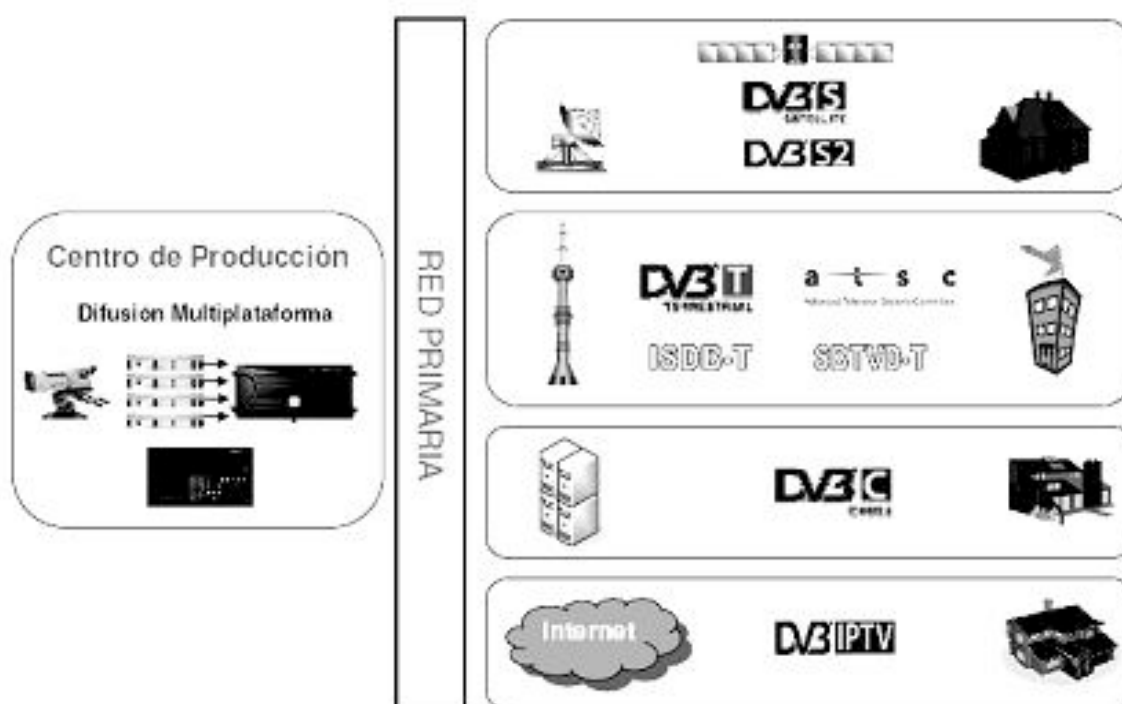

Figure 66. DVB Norms(www.dvb.org)

In short, with the new DVB standards it is possible to transmit several programs through the same channel and to choose the quality of the content broadcast with flexibility. Also, the systems introduce secure coding to limit access and to obtain a remarkable improvement in the quality of the image with immunity from interference and, in addition, extended services such as EPG-Electronic Program Guide, VOD-Video On Demand, PPV-Pay Per View, and other undoubtedly significant improvements in relation to the previous analog television systems.

Recently, high definition television, TDT-HD, is being implemented widely in an effort to raise quality standards and to compete with other means of audiovisual content distribution and other forms of entertainment that are subtracting audiences in a very significant way from the television-industry sector that until recently seemed unbeatable.

Currently, the TDT-HD broadcasting is realized with the DVB-T technology, using more bandwidth for each channel. But to optimize it, the whole system is in process of establishing a new digital terrestrial television transmission format, the so-named DVB-T2, which significantly improves the efficiency of transmission and decreases the bandwidth used. And all this, along with the new compression algorithms that are being adopted such as AVC, H.264 and others, will allow to increase very remarkably the quality of the audiovisual content distributed by television in a few years.

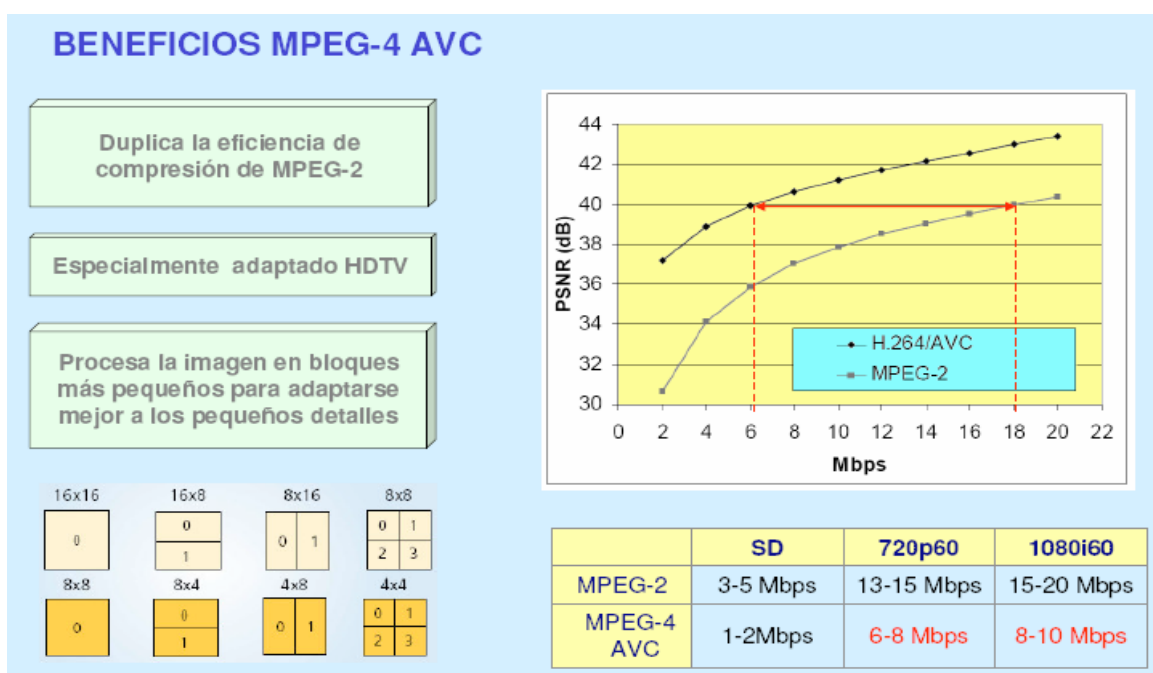

Figure 67. AVC Compression Algorithm (www.vcodex.com)

The other big venture of digital television systems since its inception is the introduction of interactivity with end users of the service, as is usual in contemporary media based on infrastructures of computer networks. However, this aspect has not yet been adequately developed and implemented due to the difficulties encountered in establishing a return channel that responds optimally to data exchange needs. Only with the integration of digital television systems in the environments of telecommunication and internet networks it has become possible, but terrestrial or satellite broadcast is still something that is far from a reality, and although there are some implementations they are scarcely developed and provide limited operability and interactive facilities, such as the purchase of payment pro-

grams and conditional access systems, by means of a card or similar, which are specific to each issuing platform and still not very standardized.

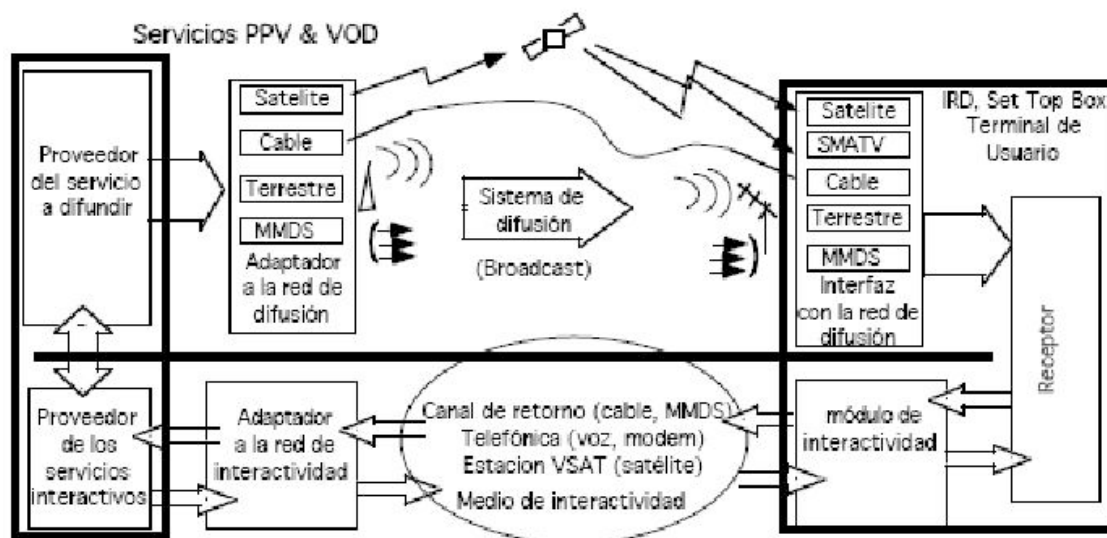

Figure 68. DTT Interactive (www.dvb.org)

4.3. Communication Networks. Internet TV

In the context of fast development of Digital Television technologies, the synergies that occur between the various telecommunication media are evident and unavoidable and, therefore, they are increasing with the development of hybrid systems that use the telecommunications platforms and infrastructures for TV contents distribution. Mobile telephony networks and the Internet are increasingly offering a faster transmission speed and, in conjunction with a significant improvement in data compression systems, news media platforms are becoming serious competitors for the traditional television broadcasting brands.

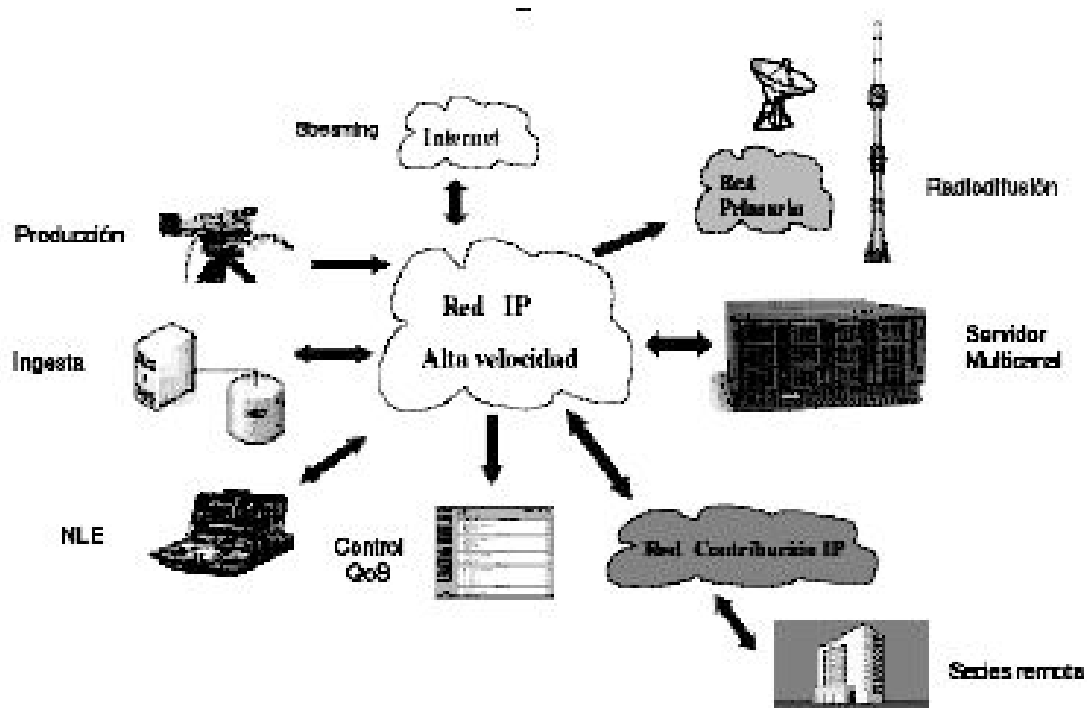

Figure 69. Internet TV (www.dvb.org)

A new standard named DVB-H and based on the original DVB-T norm has been introduced for mobile network transmission, but it has been adapted to the mobile equipment in terms of resolution and minimum power consumption, which is essential for its operation. Simultaneously, and in line with the growing development of wireless telecommunication systems, the digital television standards DVB-MS and DVB-MT have been developed to allow the deployment of infrastructures and broadcast networks in locations with disperse populations, with much lower cost of installation than the current ones, in order to make the universalization of multimedia telecommunication networks possible.

All of this is leading the industrial sector to a reorganization of the television sector and its agents. Nowadays, it involves public and private administrations and concessionaires, the content production industry, equipment manufacturers and application developers, as well as the managers of the multiplex which are news agents which are quite different to the carrier and signal diffuser, and finally also interactive managers appeared on the scene.

With regard to Internet television, the transmission norm known as IPTV that is using the TCP/IP protocol has the most promising future options, given the wide interactive possibilities and multiplatform integration that it allows, once the transmission capacity of existing internet networks has been improved. On the one hand, private data transmission networks can be established, which guarantees the quality of the contents for the users that have access, an adequate modality for payment networks with quality guarantee in the reception. On the other hand,

using internet operators makes it possible to offer television in conventional networks using P2P systems for streaming.

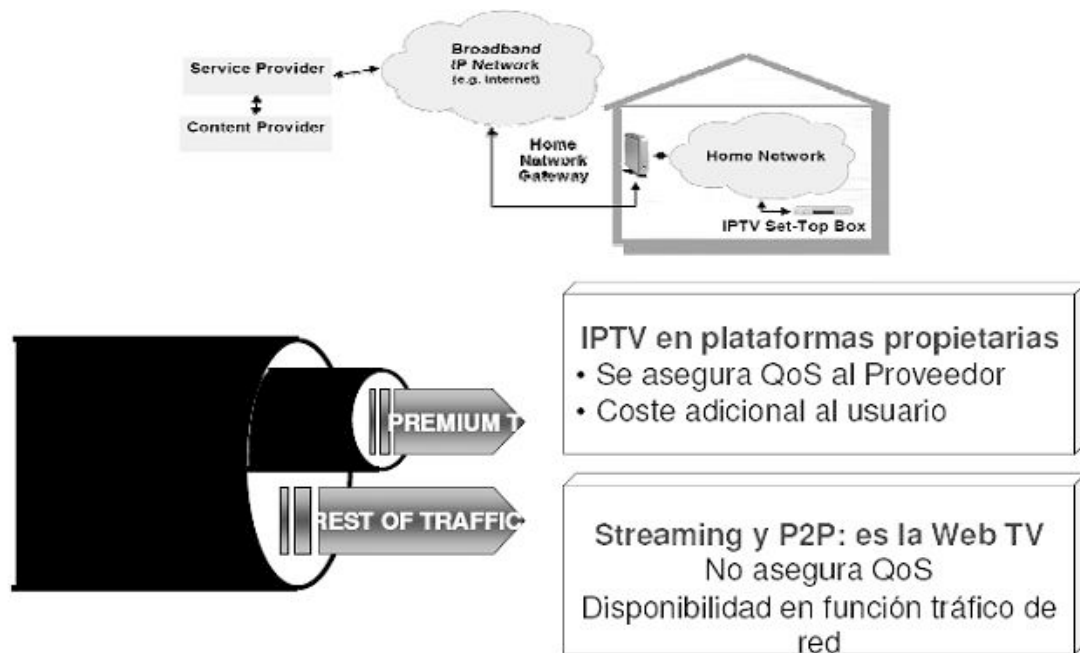

Figure 70. IPTV (Carrasco 2010)

Classic streaming systems operate with hierarchical transmission modes, that is to say, having a single transmitter constitutes the unidirectional broadcast. But if the number of users to which the signal has to reach increases, since the transmission speed is limited, it is necessary to expand the bandwidth in order not to lose quality. In contrast, P2P (peer to peer) systems are much more effective economically because being based on multinodal networks, i.e. in the form of a mesh any user receiving the signal becomes the transmitter at the same time, so that the final quality that reaches each of the users is the joint result of the network members, and the distribution of television can be extended unlimitedly without any cost, certainly a very interesting technological option to be taken into account in the immediate future.

Today, traditional television operators maintain a multicast development strategy and use both technologies, waves and internet, on their multimedia television platforms.

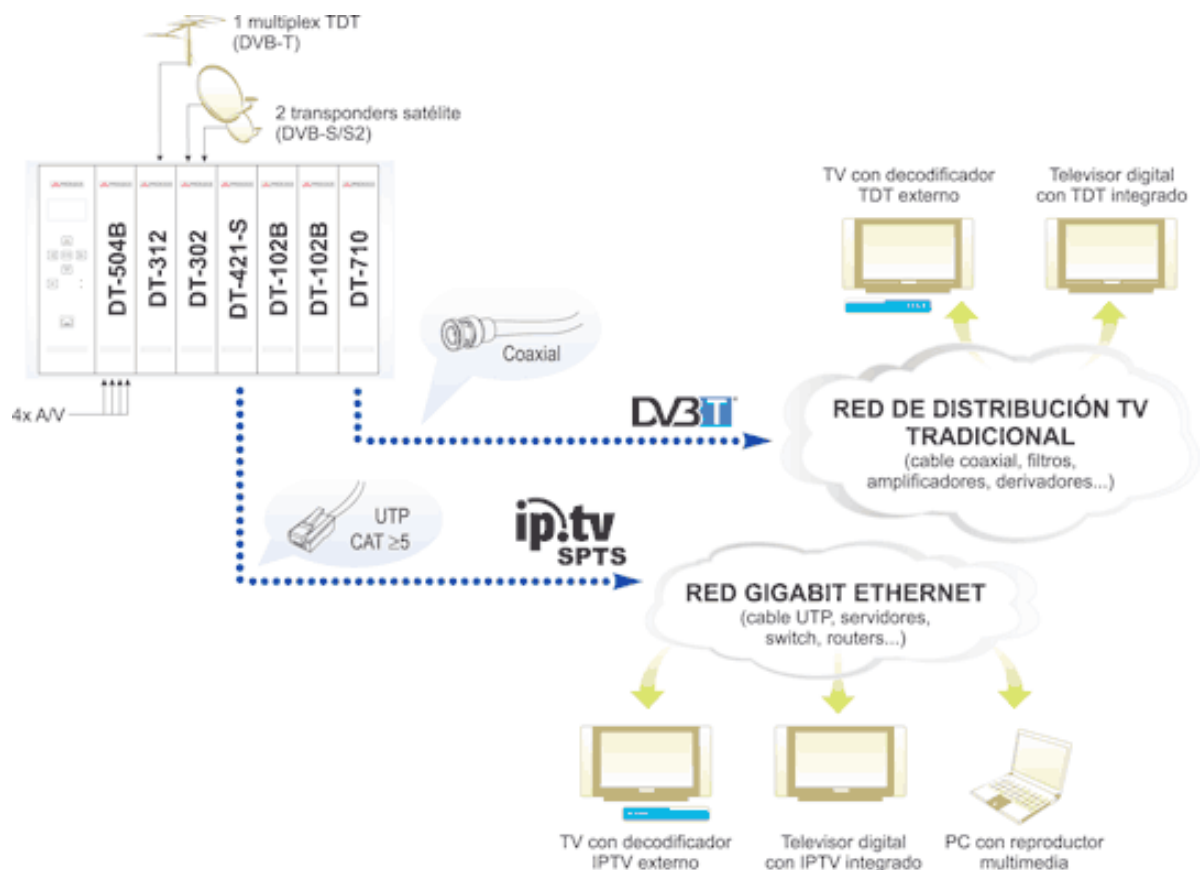

Figure 71. DVB-T / IPTV (www.dvb.org)

Summarizing, if we make a quick comparison between DTT and IPTV technologies we will see that both have their advantages and disadvantages, and surely they will share market in tense competition for some years. At least to this day, DTT offers a higher quality of image and sound and reaches the halls of all homes but, nevertheless, the IPTV television allows greater versatility in the choice of contents, it is easily adaptable to all the multimedia devices that already use the internet, and it can be complemented and integrated with many other utilities offered by these devices and the internet network itself. And more importantly, it meets the requirements of segmentation and access to audiences that the advertising industry demands, being able to direct customized campaigns much more effectively than the current DTT digital terrestrial television technology. Therefore, most certainly IPTV is going to be established as a technology for the distribution of content in the near future.

4.4. Television Monitoring and Digital Cinema Projection

In the industrial sector of hardware for viewing and the projection of images, just as it is happening within the other segments of the audiovisual industry, the fast implantation of important technological developments are taking place in the last

years, both in the professional and labor market and in the domestic video projection equipment sector.

Over the last decades, visualization technology was based on cathode ray tubes (CRTs), which we have already discussed in previous sections about electronic image. Several types of CRT screens have been on the market for a long time, designed to minimize problems arising from electron beam distortion and dispersion in the system by developing curved screens to match the beam distance of the center as well as other similar technologies. With the use of masks or grids, such as the FST (Flat Square Tube) or Trinitron system, monitors with much lower curvature than the standard ones could be made. Other companies, such as Hitachi, improved the system efficiency and resolution focusing on how to implement phosphorus by reducing the horizontal distance between each pixel and creating oval structures rather than round color points to improve the final quality.

In this sense, despite its drawbacks, CRT projection is currently considered a robust, mature and well-known technology that allows a high resolution and provides excellent quality and image control.

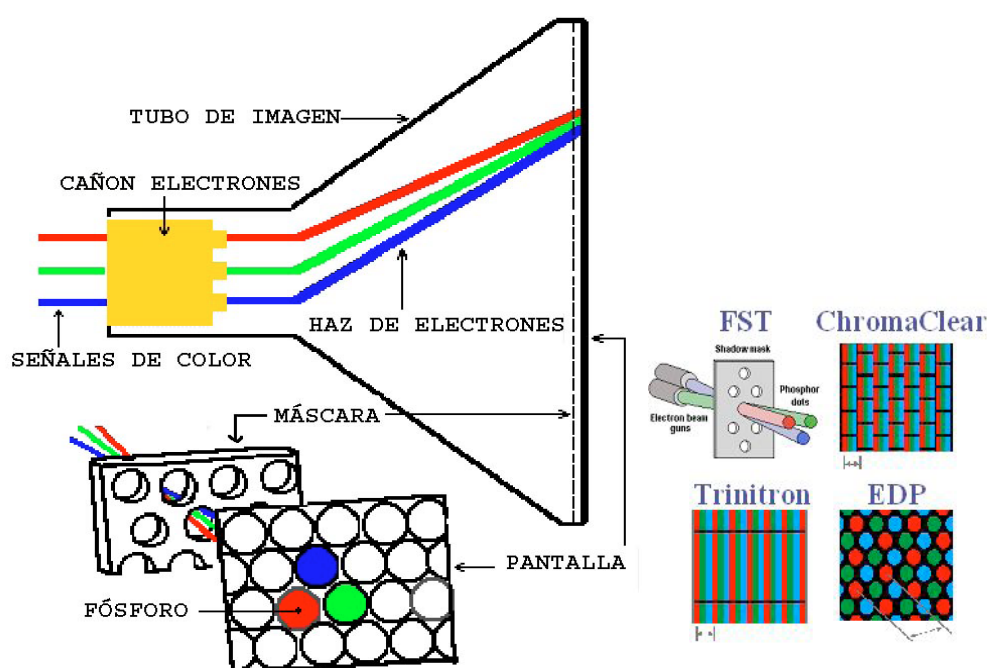

Figure 72. CRT System Screen (www.sony.com)

In recent years, the LCD (Liquid Crystal Display) projection has been established and extended widely at the professional and domestic level within a few decades up until now. The liquid crystal displays are based on the filtering of light from the use of two filters placed perpendicular to each other that let pass or not the light, depending on their polarity. When applying an electric current to the second of them, and therefore change the polarity, we will let pass or not the light that

crosses the first through the second, depending on the electric intensity supplied. To obtain the full colors red, green and blue filters are added which are distributed for each pair of liquid crystal of different polarization.

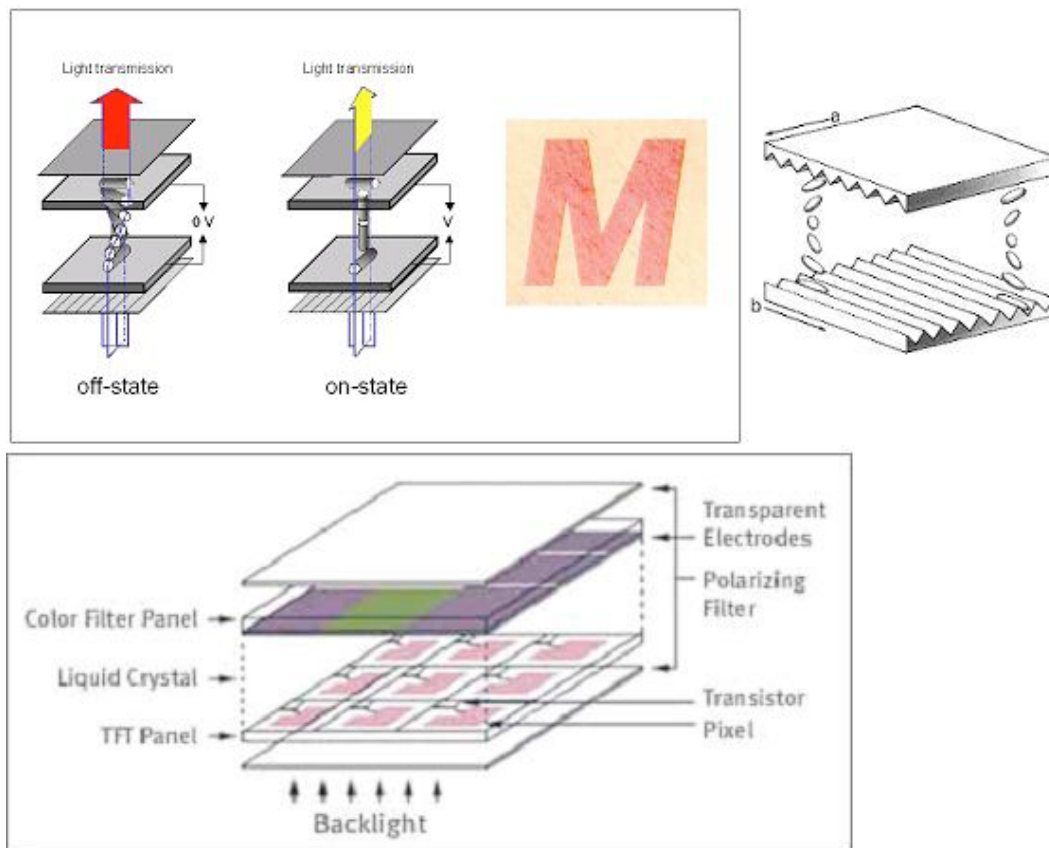

Figure 73. LCD Screen System (www.sony.com)

We can find two types of LCD screens, the so-called passive matrix and the active matrix. The first ones are designed with a base of horizontal conductive lines aligned and arranged from one end to the other of the screen, which generates a problem due to the longer time used to activate each element and to refresh the screen, especially in large-size screens. This drawback has been minimized, but only in part, with what has been named Dual Scan, i.e. dividing each line into two sections that are scanned from the nearest end. However, they are still less effective than those of the second LCD type, the active matrix, commonly installed in most monitoring devices because it allows a greater viewing angle and operates much faster. They are designed from a grid of independent transistors located in a layer below the screen elements, therefore LCDs are much more complex to manufacture and expensive, but also much more efficient by allowing to address individually each element of the image.

The third of the most implemented technologies, PDP, basically operates using plasma screens, and it is actually a very old and well-known technology, because

it is based on the known properties of certain gases that emit light when they receive electric power. This principle was already experienced by John L. Baird and then considered as a possible way to produce images on a screen, although it was not possible to develop projection equipment with this technology until the last decades of the twentieth century.

The first plasma screens were built with two layers covered by conductive lines between which Neon gas was trapped, and they were monochrome, with a low resolution and very inefficient in terms of power consumption. The functioning was similarly to the LCD screens, by passing the electric current through each conductive line the gas excited the production of an image. Current PDPs contain a mixture of gases which when activated electrically emit UV light, i.e. ultraviolet radiation that is used to excite an overlapping phosphor layer, similar to what happened on CRTs screens. The PDP displays provide a very good resolution and high refresh rate while significantly reducing the volume and weight of the equipment, thus large-sized flat screens can be marketed in this way. They have the disadvantage of their limited useful life due to the fact that undesired effects of burning of the pixel cell might occur, and their manufacturing cost is also higher, so they have been set aside on the market after the establishment of the LCDs.

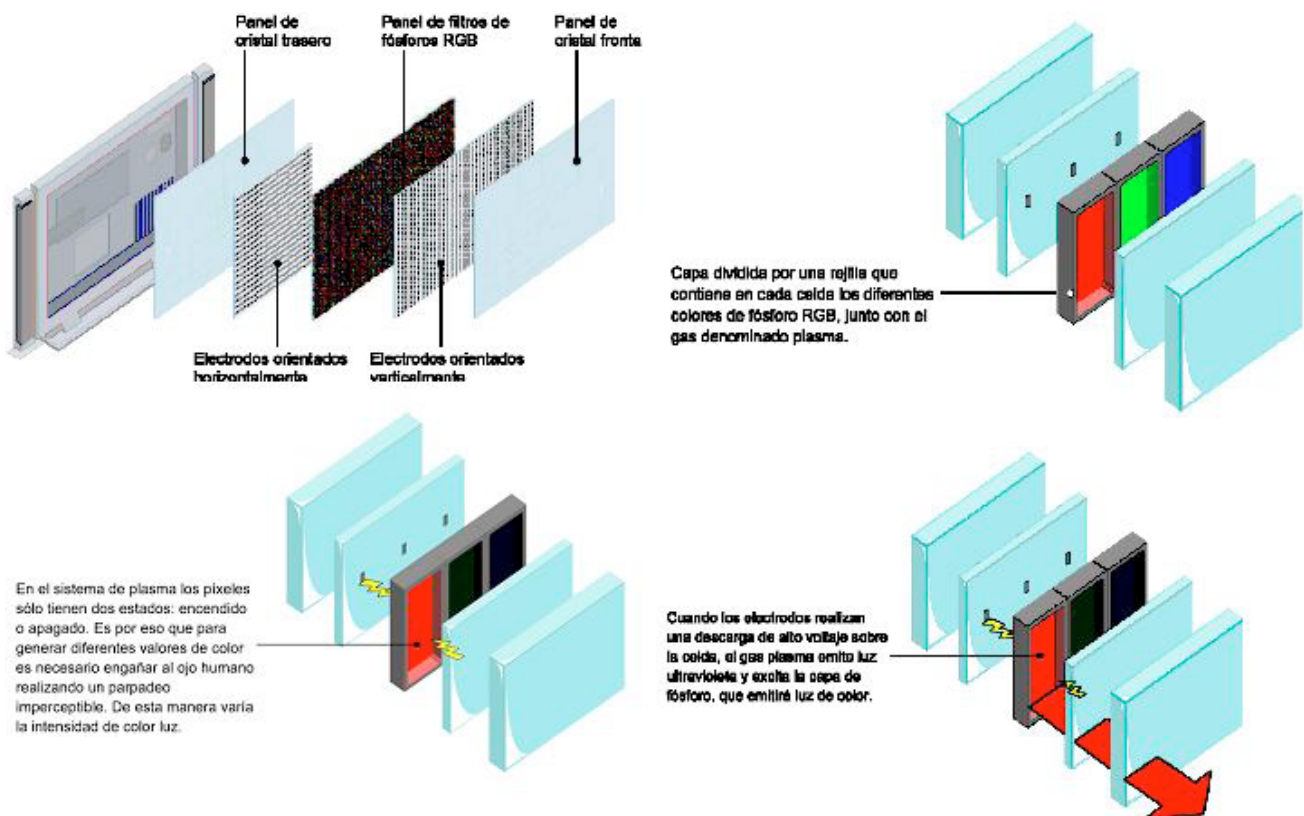

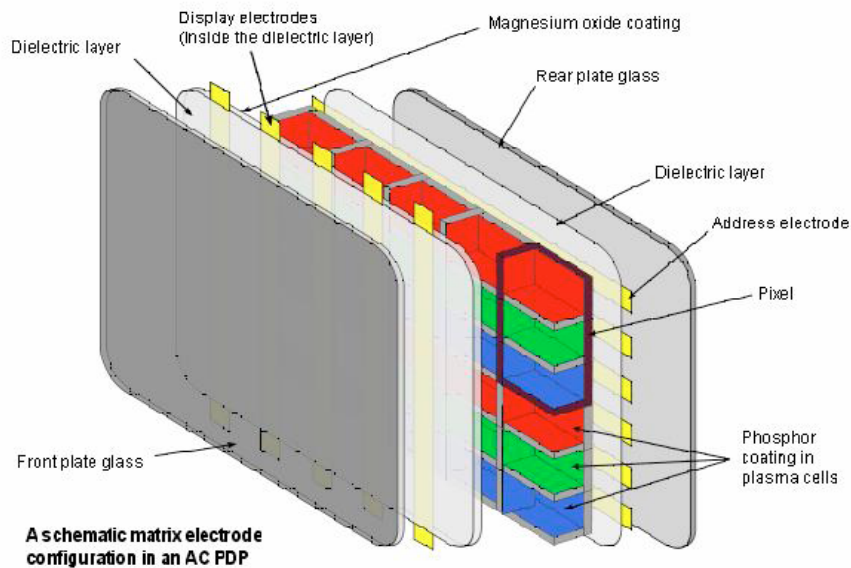

Figure 74. PDP Screen System (www.sony.com)

Among the latest developments in image monitoring systems are the new SED (Surface-Conduction Electron-emitter Displays) technology, developed by companies such as Toshiba and Canon. The screen with this technology works by projecting electrons that excite a layer of phosphorus, similar to the CRT systems but allowing the commercialization of tiny screens.

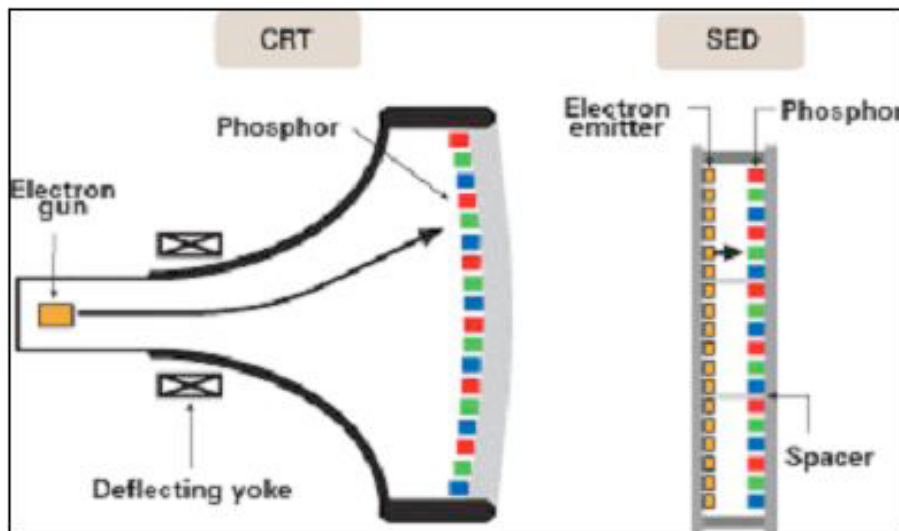

Figure 75. SED Screen (www.toshiba.com)

Other technological developments that have been established fast are based on the properties of OLED (Organic Light-Emitting Diode) materials. The design of

the screens is made by arranging a layer of organic components that react to electrical stimulation producing light of the color of the used material. Today LED / OLED screens are commonly used in all audiovisual equipment and multimedia mobile devices, because their pixels are directly addressable and this technology significantly reduces electrical consumption compared to others at low manufacturing costs, and also because it allows to build flexible screens.

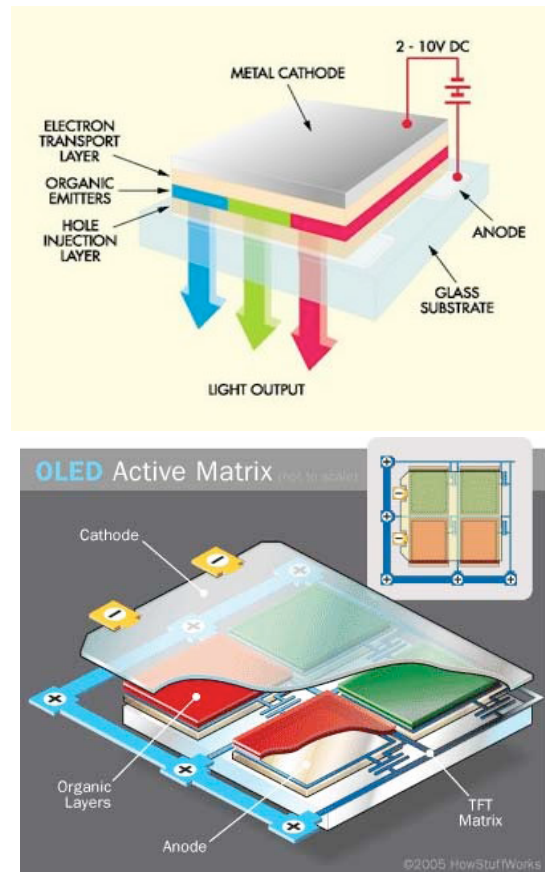

Figure 76. OLED Screen Technology (www.sony.com)

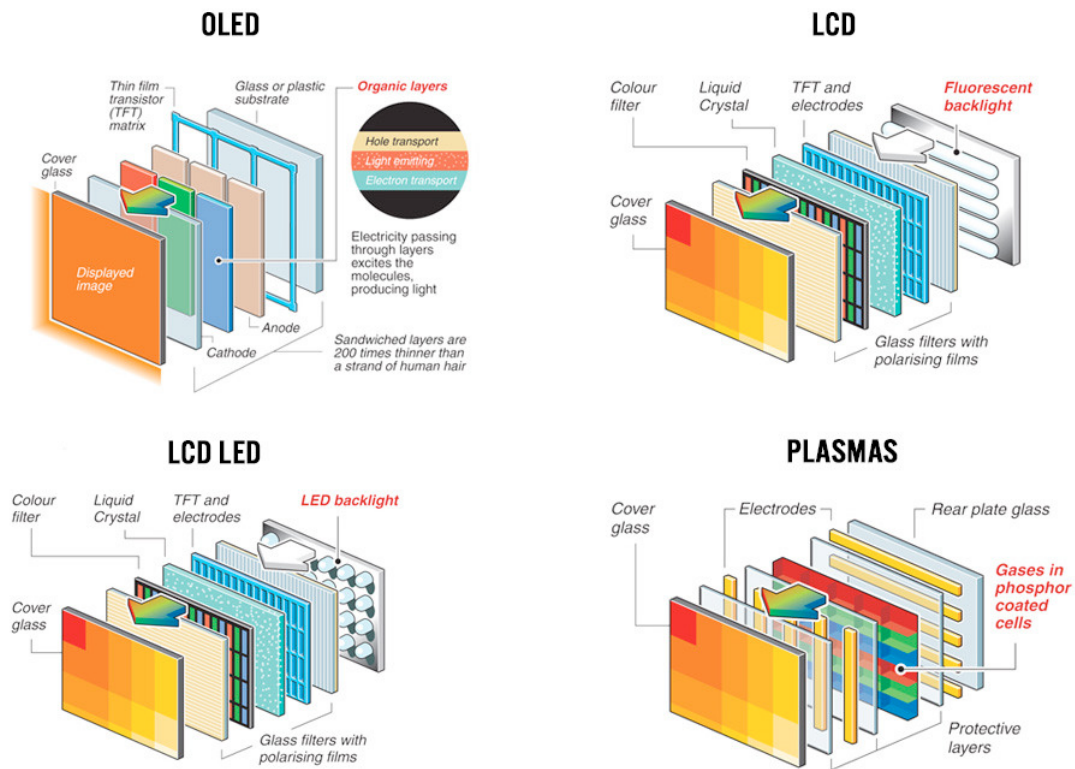

Figure 77. Comparison between different technologies (www.panasonic.com)

As for the technological segment of audiovisual equipment addressed to the spectacular projection to large audiences, the described technologies are increasingly being implemented, although they still do not reach the enormous screen sizes necessary for it, and other projection technologies still prevail. In projection equipment for large rooms, the most-established technology is the one developed initially by Texas Instruments and known as DLP (Digital Light Processing), which is marketed also by some other brands such as Barco and NEC. The DLP technology consists of a system of a chip and a, mobile circular filter, or three chips of moving mirrors with a filter for each color on which the light is passed after dividing the beam by means of a color decomposition prism. The projection equipment currently commercialized allows resolutions from 2k (2048x1080) or, more commonly, 4k (4096x2160), thus being able to represent from 16.7 million to 35 trillions of colors, while resolution figures are constantly increasing, and with improvements every time, most notably referring to the quality of the projected image.

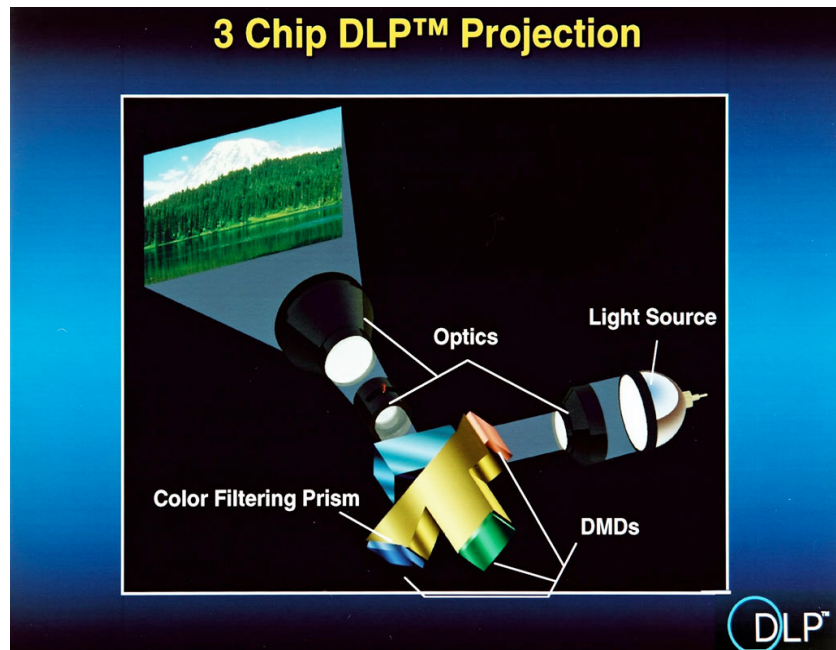
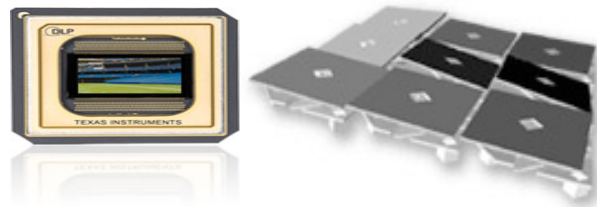

Figure 78. DLP Projection System (www.barco.com)

In this special industrial sector of spectacular projection other brands, such as Sony or JVC, are developing and commercializing systems with their own technologies in which they use other chip types. In the case of Sony and JVC, their projectors use silicon chips, in the denominated system SXRD and D-ILA respectively, although its principles of operation are similar to DLP systems.

The general tendency, in any case and as we have already pointed out, is the digitization of all audiovisual processes and, in this specific area of projection, the industrial efforts are aimed to replacing the classical film projection systems by digital equipments in optimum quality conditions. There is also a growing interest in increasing the spectacularity of images by implementing 3D systems in some cinemas, but actually without the success expected by the industry.

In the present, above all, there is a fast trend towards the integration of projection systems for large audiences and especially for the development of content production and distribution architectures based on telecommunication networks as well as the implementation of audiovisual systems that facilitate the full availability of content right away, in order to increase productivity and allow cost reduction and therefore to improve the profitability of the film and audiovisual industry.

Bibliography

Basic Bibliography

Browne, Steven. 2007. *Postproducción de Alta Definición*. Andoain, Escuela de Cine y Vídeo.

Carrasco, Jorge. 2010. *Cine y televisión digital. Manual técnico*. Barcelona: Univ. de Barcelona.

Lancaster, Kurt. 2011. *Cine DSLR*. Madrid: Anaya.

Millerson, Gerald. 2009. *Realización y producción en televisión* (4ª ed.). Madrid: IORTV.

Pavlik, John. 2015. *Digital Technology and the Future of Broadcasting*. New York: Routledge.

Rajas, Mario. 2013. *Tecnologías audiovisuales en la era digital*. Madrid: Fragua.

Wheeler, Paul. 2008. *Cinematografía en alta definición*. Barcelona: Omega.

Complementary Bibliography

- Alten, Stanley. 2008. *El manual del audio en los medios de comunicación*. Andoain (Guipúzcoa): Escuela de cine y vídeo.
- Barroso, Jaime. 2008. *Realización audiovisual*. Madrid: Síntesis.
- Beach, Andy. 2009. *Técnicas de compresión de vídeo*. Madrid: Anaya.
- Bestard Luciano, María. 2011. *Realización audiovisual*. Barcelona: UOC
- Brown, Blain. 2012. *Iluminación para cine y vídeo (2ª Edición)*. Andoain: Escuela de Cine y Vídeo.
- Castillo Pomedá, Jose. 2010. *Televisión, realización y lenguaje audiovisual*. Madrid : IORTV.
- Cuenca, Ignasi y Gómez, Eduard. 2005. *Tecnología básica del sonido (I y II)*. Madrid: Paraninfo.
- Espinosa, Cinto. 2012. *Fonaments i usos de tecnologia audiovisual digital*. Barcelona: UOC
- Félix Molero, Emilio. 2006. *Sistemas de radio y televisión*. Madrid: McGraw-Hill.
- Guillén, Paloma. 2012. *Final Cut Pro X*. Madrid: Anaya.
- Lanford, Michel. 1994. *Tratado de fotografía*. Barcelona: Omega.
- Llorens, Vicente. 2004. *Fundamentos tecnológicos de vídeo y televisión*. Barcelona: Paidós.
- Luque, Ramón y Dominguez, Jose. 2011. *Tecnología digital y realidad virtual*. Madrid: Fragua.
- Mappe, Louis. 1993. *La película y el laboratorio cinematográfico*. Andoain (Guipuzcoa): Escuela de Cine y Vídeo.
- Martínez Badía, José y Serra Flores, Jordi. 2000. *Manual básico de técnica fotográfica y dirección de fotografía*. Barcelona: Paidós.

- Martínez Badía, José. 2009. *Manual básico de tecnología audiovisual y técnicas de creación, emisión y difusión de contenidos*. Barcelona: Paidós.
- Marzal Felici, Javier y López Cantos, Francisco. 2008. *Teoría y técnica de la producción audiovisual*. Valencia: Tirant lo Blanch.
- Melendreras, Rafael (coord..). 2012. *Guía para el usuario de la Televisión de Alta Definición*. Madrid: ImpulsaTDT
- Morales Morante, Fernando. 2013. *Montaje audiovisual. Teoría, técnica y métodos de control*. Barcelona: UOC.
- Pérez, Constantino y Zamanillo, Jose. 2003. *Fundamentos de televisión analógica y digital*. Oviedo: Universidad de Cantabria.
- Rodero, Emma. 2011. *Creación de programas de radio*. Madrid: Síntesis.
- Rumsey, Frank y McCormick, Tim. 2004. *Sonido y grabación. Introducción a las técnicas sonoras*. Madrid: IORTV.
- Serra Sánchez, Jordi y García García, Francisco. 2014. *Tecnología y narrativa audiovisual*. Madrid: Fragua.
- Simpson, Robert S. 2004. *Control de la iluminación. Tecnología y aplicaciones*. Andoaín: Escuela de Cine y Vídeo.