

Accepted Manuscript

Title: Experimental assessment of r134a and its lower GWP alternative R513A

Author: Adrián Mota-Babiloni, Pavel Makhnatch, Rahmatollah Khodabandeh, Joaquín Navarro-Esbrí

PII: S0140-7007(16)30406-6

DOI: <http://dx.doi.org/doi: 10.1016/j.ijrefrig.2016.11.021>

Reference: IJIR 3489

To appear in: *International Journal of Refrigeration*

Received date: 19-8-2016

Revised date: 6-11-2016

Accepted date: 28-11-2016

Please cite this article as: Adrián Mota-Babiloni, Pavel Makhnatch, Rahmatollah Khodabandeh, Joaquín Navarro-Esbrí, Experimental assessment of r134a and its lower GWP alternative R513A, *International Journal of Refrigeration* (2016), <http://dx.doi.org/doi: 10.1016/j.ijrefrig.2016.11.021>.

This is a PDF file of an unedited manuscript that has been accepted for publication. As a service to our customers we are providing this early version of the manuscript. The manuscript will undergo copyediting, typesetting, and review of the resulting proof before it is published in its final form. Please note that during the production process errors may be discovered which could affect the content, and all legal disclaimers that apply to the journal pertain.

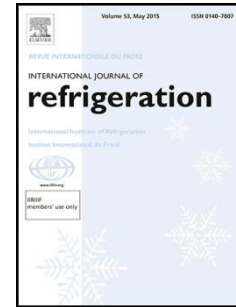

Experimental assessment of R134a and its lower GWP alternative R513A

Adrián Mota-Babiloni^{a,b,c,*}, Pavel Makhnatch^c, Rahmatollah Khodabandeh^c,
Joaquín Navarro-Esbrí^b.

^a Institute for Industrial, Radiophysical and Environmental Safety (ISIRYM), Camino de Vera s/n, Polytechnic University of Valencia, E-46022 Valencia, Spain.

^b ISTENER Research Group, Department of Mechanical Engineering and Construction, Campus de Riu Sec s/n, University Jaume I, E-12071 Castellón de la Plana, Spain.

^c Royal Institute of Technology, Department of Energy Technology, Division of Applied Thermodynamics and Refrigeration, Brinellvägen 68, 100 44 Stockholm, Sweden

HIGHLIGHTS

- R513A is experimentally compared with R134a in a refrigeration test bench.
- Evaporation temperatures are varied between -15 and 12.5°C.
- R513A presents higher mass flow rate and cooling capacity than R134a.
- R513A COP is always above than that of R134a due to lower cooling capacity.
- R513A can substitute R134a with lower system modifications.

Abstract

Lower GWP refrigerants are essential to mitigate the impact of refrigeration systems on climate change. HFO/HFC mixtures are currently considered to replace HFCs in refrigeration and air conditioning systems. The aim of this paper is to present the main operating and performance differences between R513A (GWP of 573), and R134a (GWP of 1300), the most used refrigerant for medium evaporation temperature refrigeration systems and mobile air conditioners. To perform the experimental comparison, 36 tests are carried out with each refrigerant at evaporating temperatures between -15 and 12.5°C and condensing temperatures between 25 and 35°C. The conclusion of the experimental comparison is that R513A can substitute R134a with only a thermostatic expansion valve adjustment, achieving better performance and higher cooling capacity. The discharge temperature of R513A is always lower than that of R134a.

* Corresponding Author:

Tel: +34 964387529; fax: +34 964728106.

E-mail address: admoba@upv.es

Keywords: R134a, R513A, Global Warming Potential, energy efficiency, experimental comparison, HFO/HFC mixtures

Nomenclature

COP coefficient of performance

h enthalpy (kJ kg^{-1})

\dot{m}_{ref} refrigerant mass flow rate (kg s^{-1})

\dot{Q}_{evap} cooling capacity (kW)

T temperature ($^{\circ}\text{C}$)

P_c motor-compressor electrical power consumption (kW)

Subscripts

in inlet

c condenser

$evap$ evaporator

out outlet

Abbreviations

GWP Global Warming Potential

HFC Hydrofluorocarbon

HFO Hydrofluoroolefin

NBP Normal Boiling Point

ODP Ozone Depletion Potential

TXV Thermostatic Expansion Valve

1. Introduction

Hydrofluorocarbon (HFC) substances were included in greenhouse gas basket by Kyoto protocol (UN, 1997) due to their great contribution to climate change compared to carbon dioxide. These fluids were widely used in different applications as working fluids (refrigerants) of refrigeration and air conditioning systems, building insulation (foams), fire extinguishing systems and aerosols. Among these uses, the major use of HFCs is as refrigerants (Calm, 2002).

The most used refrigerant HFCs are R404A, R134a and R410A, each one of them in different refrigeration and air conditioning applications (Mota-Babiloni et al., 2015a). R134a is dominating the medium temperature refrigeration and air conditioning systems of developed countries, and more and more, these appliances of developing countries, at the same time that R12 (Carpenter, 1992) is being replaced according to Montreal Protocol chlorofluorocarbon phase out schedule.

In Europe, the Regulation (EU) No 517/2014 (The European Parliament and the Council of the European Union, 2014) establishes the phase out of higher Global Warming Potential (GWP) fluids for different refrigeration and air conditioning applications. R134a is banned in domestic refrigerators and freezers since 2015 and will be retired from commercial refrigerators and freezers from 2022; and hence replacements for this refrigerant must be found. In that applications where it can still be used (commercial stationary refrigeration equipment and primary circuit of cascade systems of multipack centralized refrigeration systems), low GWP alternatives (McLinden et al., 2014) should be prioritized to prevent harmful consequences of climate change (Velders et al, 2015).

Natural refrigerants are a good option from an environmental point of view because their GWP near unity. Among them hydrocarbons are highlighted (Palm, B., 2008), which can directly compete with R134a in low charge systems (Joybari et al., 2013 have proved that the amount of charge required for R600a is 66% lower than for R134a); and carbon dioxide in transcritical cycle (Aprea et al., 2013).

Regarding synthetic environmental friendly alternative refrigerants, a new class of them has emerged the past decade, the hydrofluoroolefins. The most implemented of them are R1234yf and R1234ze(E), and also their GWP is equal or below unity (Sethi et al., 2016). These fluids offer some issues (low flammability or insufficient cooling capacity) related to their use in existing R134a systems (Mota-Babiloni et al., 2014), so blends of HFOs (hydrofluoroolefins) and HFCs are being recently developed to mitigate the drawbacks of these HFOs while keeping GWP values low. R513A (mixture of R134a and R1234yf) and R450A (mixture of R134a and R1234ze(E)) are today the most relevant non-flammable HFO/HFC mixtures for medium temperature refrigeration and air conditioning systems. Despite that, few data about the behavior of these fluids is available in literature, mainly focused on R450A: an energetic comparison with R134a (Mota-Babiloni et al., 2015b), an analysis of the effect of the internal heat exchanger (Mota-Babiloni et al., 2015c) and a model developed using this fluid and others

(Mendoza-Miranda et al., 2016). Investigations of R1234yf and R134a mixtures are still more focused on thermophysical properties (Akasaka et al., 2015) and compatibility with POE lubricant oil (Sedrez and Barbosa Jr, 2015).

Before the worldwide acceptance and implementation of R513A as lower GWP working fluid in the vapor compression systems, more research about the behavior of this fluid is needed. It is very important to know the adaptation of this refrigerant in R134a systems performing a light retrofit replacement. This paper presents an experimental analysis of the retrofit replacement of R513A as lower GWP alternatives for R134a. These fluids are tested in a refrigeration test bench equipped with a hermetic rotary compressor and plate condenser and evaporator. Several condensation and evaporation temperatures are selected to cover a wide range of operating conditions and then the main parameters resulting from the experimentation are presented and discussed.

2. Main characteristics of R513A as R134a alternative

The main characteristics of R134a and its lower GWP alternative are displayed in Table 1.

Table 1. Main characteristics of R134a and the commercial HFO/HFC mixtures

R513A is composed by R134a/R1234yf at 44/56 of mass percentage, being a zero-ODP (ozone depleting potential) fluid and meets the limitation established on the Montreal Protocol. R513A has a GWP value of 573 and it can be used in the same applications that R134a is allowed (refrigerators and freezers for commercial use until 2020, stationary refrigeration equipment and multipack centralized refrigeration systems for commercial use) but achieving great reduction in direct CO₂ equivalent emissions.

Similarly to R134a, R513A is classified as nontoxic and nonflammable fluid (A1) by ASHRAE, so the flammability is not a concern. The normal boiling point (NBP) is very similar between both refrigerants, so R513A can also be used in food conservation systems. R513A was classified as azeotrope mixture by ASHRAE (R500 series) because its glide can be considered negligible (average glide of 0.1°C).

Analyzing the thermophysical properties of this refrigerant, R513A shows lower liquid thermal conductivity, liquid viscosity and latent heat; and higher vapor density. This could affect the heat transfer coefficient in heat exchangers and R513A would show higher mass flow rate but lower refrigerating effect. From a brief theoretical overview of the performance of the refrigerants (Table 2), R513A depicts slightly lower performance but higher cooling capacity. Simulating conditions are -5 and 30°C for evaporating and condensing temperature, superheating and subcooling degree of 10.5 and 7°C respectively, and isentropic and volumetric efficiency of 0.8.

Table 2. Theoretical overview of R513A and R134a performance.

3. Experimental procedure

3.1. Experimental setup

To perform the experimental comparison between R513A and R134a, a fully instrumented vapor compression system test bench was used, Figure 1.a). The components present in the test bench are shown in a schematic view, Figure 1.b). It is comprised by the main circuit, which simulates the operation of a vapor compression system, and two secondary circuits; one glycol/water brine close loop for the evaporator and one water open loop for the condenser.

Figure 1. a) Experimental test bench and b) schematic diagram.

The installation is composed by four main elements, common to every vapor compression system:

- A full hermetic rotary compressor designed for R134a. The motor rating is 550W and the displacement is 15.44 cm³ per revolution. The oil used was polyolester and its return to compressor is ensured by the usage of an oil separator.
- An evaporator and condenser plate heat exchangers designed to work with R134a at medium temperature refrigeration conditions.
- An R134a thermal expansion valve (TXV).

The two secondary circuits allow controlling the operating conditions of the vapor compression circuit. The secondary circuit of the evaporator is a close loop composed by a pump that drives a ethylene glycol/water brine (43/57 in mass percentage) heated by an adjustable three phase resistance of 2.6 kW rated power. The secondary circuit of the condenser is a running water open loop which flow is controlled by a water regulating valve.

The measuring instrumentation of the system is described in the following:

- The temperatures at the inlet and the outlet of each main component (main and secondary circuits) are measured by thermocouples T type with $\pm 0.11^{\circ}\text{C}$ of uncertainty.
- The condensation and evaporation pressure are measured by two calibrated pressure sensor transducers with $\pm 0.08\%$ of uncertainty (full scale best straight line). The maximum measurement of the low pressure transducer is 1000kPa and that of the high pressure transducer is 2000kPa.
- The evaporation pressure drop is measured by a differential pressure sensor of 0.25% of uncertainty (reading).
- The refrigerant mass flow rate is measured by a Coriolis type flow meter with $\pm 0.5\%$ uncertainty (reading).
- The electric consumption of motor-compressor set and the heaters is registered by a configurable multi transducer with $\pm 0.2\%$ uncertainty (reading).

Finally, all the measurements are collected by a data acquisition system and gathered to a personal computer, in which the data is displayed and registered. It should be noted that the components and the pipes of the system are completely isolated to minimize losses to ambient and allow measuring more accurate results.

3.2. Tests conditions

The performed tests are intended to simulate the operating conditions of a typical small cooling capacity refrigeration system. Six evaporating and three condensing temperatures were established for each refrigerant, Table 3. When the alternative refrigerant was introduced, a retrofit replacement was performed: the superheating degree was adjusted through the screw of the thermal expansion valve and the subcooling degree controlling the amount of refrigerant introduced in the main circuit.

Table 3. Tests operating conditions.

Once measured each steady-state experiment (20 min length minimum), the average steady-state output parameters are obtained.

3.3. Equations

First, the cooling capacity (\dot{Q}_o) is obtained using Equation (1). The enthalpy at the outlet and the inlet of the evaporator are obtained using REFPROP v9.1. (Lemmon et al., 2013) and the pressure and temperature measurements. The mass flow rate is directly measured from the installation using the Coriolis mass flow meter.

$$\dot{Q}_{evap} = \dot{m}_{ref} (h_{out} - h_{in})_{evap} \quad (1)$$

The cooling capacity measurement is validated by a power meter that registers the electrical power consumed by the heater. Figure 2 shows the evaporator heat balance of both refrigerants tested. Although the heater power is below that of that measured in the refrigerant side, the deviation both values remains always below 15%. The deviation is greater at lower heat transfer values, this is due to the losses to the ambient, that are greater at low evaporating temperatures.

Figure 2. Evaporator heat balance

Then, the Coefficient of Performance (COP) of the refrigeration system is calculated using Equation (2). The motor-compressor power consumption is obtained from the power meter measurements.

$$COP = \dot{Q}_{evap} / P_c \quad (2)$$

Through the RSS method (Taylor, 1997), the uncertainties for the calculated parameters were obtained. Thus, the average cooling capacity uncertainty for R134a is 0.38% and for R513A and 0.37%. Regarding COP, the average uncertainty for R134a is 0.43% and for R513A and 0.42%.

4. Results and discussion

This section presents and discusses the parameters used to analyze the behavior of the lower GWP alternative to R134a, R513A. The main parameters studied are mass flow rate, cooling capacity, COP and discharge temperature. These values are represented against the evaporating temperature at different condensing temperatures (maximum deviation $\pm 0.1^\circ\text{C}$). The maximum variation of superheating degree was $\pm 1^\circ\text{C}$ and the subcooling varied depending on the operating conditions and superheating degree adjustment. The ambient temperature varied between 25.1 and 28.2°C for both fluids.

4.1. Mass flow rate

The experimental mass flow rate depends on the suction density, compressor geometrical parameters (geometrical volume of 15.4 cc and 2850 rpm), and compressor volumetric efficiency. In section 2 was shown that R513A vapor density is more than 20% higher than R134a, therefore from a theoretical point of view a greater R513A mass flow rate can be expected. Figure 3 presents the mass flow rate measured for both refrigerants at different operating conditions.

Figure 3. Experimental mass flow rate at different evaporating and condensing temperatures

Thus, taking into account what is shown in Figure 3, experimental results confirm the greater mass flow rate of R513A. The difference between both fluids is greater than expected due to greater compressor volumetric efficiency (lower R513A compression ratio and superheated vapor viscosity at the same operating temperatures) influenced by lower lower operating compression ratio (between 2 and 6% lower). The volumetric flow rate values of R513A vary between 0.81 and 0.96, and for R134a between 0.72 and 0.96. The experimental mass flow rate values of R513A were measured between 5.7 and 16.6 gr s^{-1} and that of R134a were between 4.1 and 14.3 gr s^{-1} .

Moreover, as Table 4 shows, velocities of both refrigerants were similar (slightly higher for the alternative) so there is no need for a piping redesign in R134a refrigeration systems to use R513A.

Table 4. Minimum and maximum experimental velocities at the test bench lines

4.2. Cooling capacity

As stated in Equation (1), the cooling capacity depends on the mass flow rate and the refrigerating effect (evaporator enthalpy difference). At similar subcooling and operating conditions, the R134a presents around 12% higher evaporator enthalpy difference than R513A (corresponding to a higher R134a latent heat of vaporization). So, the resulting cooling capacity is presented in Figure 4.

Figure 4. Cooling capacity at different evaporating and condensing temperatures

Taking into account what exposed before about parameters that affects the cooling capacity, the difference of mass low rate between both fluids is greater than that of refrigerating effect, so the R513A cooling capacity is greater than R134a. The cooling capacity measured using R513A is comprised between 827 and 2691W and that of R134a is between 712 and 2668 W and the differences were higher at lower evaporating and condensing temperatures.

4.3. COP (Coefficient of Performance)

Since COP depends on the cooling capacity and the electrical power consumption, the behavior of the second parameter is shown in Figure 5.

Figure 5. Power consumption at different evaporating and condensing temperatures

Electrical power consumption of R513A is greater than that of R134a, in spite of presenting between 7 and 14% lower specific compression work and higher global compressor-motor efficiency (even though both present isentropic efficiencies between 0.45 and 0.62). The lower electrical power consumption is due to the higher R513A mass low rate observed before.

Dividing cooling capacity and the compressor-motor power consumption results the COP, shown in Figure 6.

Figure 6. COP at different evaporating and condensing temperatures

The higher R513A COP can be explained from two perspectives: 1) lower R513A compression specific work than refrigerating effect differences with R134a, or 2) higher R513A cooling capacity than power consumption differences with R134a. R513A COP difference with R134a is greater at lower condensing temperatures and it can be explained by the lower R513A critical point. Moreover, the difference is also higher at lower evaporating temperatures. The R513A COP values are comprised between 1.8 and 6.8 and those of R134a between 1.6 and 6.9.

Thus, it can be concluded that the major performance increase replacing R134a with R513A is obtained at medium-low temperature refrigeration systems, working in cold climates.

4.4. Discharge line temperature

Figure 7 represents the measured discharge line temperatures. As commented before, R513A has lower specific compression work, so together with a similar isentropic efficiency (maximum difference of 3%), gives the lower R513A discharge temperature and prevents from a lubricant degradation or compressor malfunction that could end with a shorten in compressor lifetime, that can appear at high ambient temperatures. The maximum discharge line temperature using R513A at the proposed conditions was 70.5°C (maximum discharge compressor temperature varies among the different models, but it could be problematic from 100°C), while R134a measured discharge temperatures are over 80°C.

Figure 7. Discharge line temperatures at different evaporating and condensing temperatures

5. Conclusions

This article presents and discusses an experimental comparison between R513A and R134a. R513A is a lower GWP HFO/HFC mixture that was recently commercialized. 36 experimental tests were performed with each refrigerant using a vapor compression system test bench, in order to obtain enough data to perform the comparison and cover a wide range of operating conditions. The main conclusions of the study are the following.

R513A is a blend composed by R134a/R1234yf at 44/56 mass (percentage) with a GWP value of 573 and it is a non-toxic and non-flammable fluid. Experimental mass flow rate of R513A is higher than R134a because of higher suction density and lower operating compression ratio. This difference overcomes the lower R513A refrigerating effect and makes R513A performing higher cooling capacity than R134a. Even though R513A power consumption is greater than R134a, the resulting COP is higher, 5% as average, so it can be concluded that R513A is more efficient refrigerant under the tested conditions. Best R513A performance results are obtained at low evaporating and condensing temperatures, in which there is no risk of oil degradation because of the lower R513A discharge temperature.

Considering both GWP reduction and energy efficiency increase achieved using R513A, the use of this refrigerant can be recommended for refrigeration and air conditioning systems that uses R134a. In comparison with R134a, R513A could provide benefits from energetic and environmental point of views. Moreover, the direct replacement of R134a with R513A only required a TXV adjustment.

Acknowledgements

The authors thankfully acknowledge Spanish Ministry of Education, Culture and Sport for supporting this work through “Becas y Contratos de Formación de Profesorado Universitario del Programa Nacional de Formación de Recursos Humanos de Investigación del ejercicio 2012 (Grant number FPU12/02841)” and “Ayudas complementarias para beneficiarios de ayudas

(FPU): Estancias Breves. Convocatoria 2015 (Grant number EST15/00154)". Authors are also grateful to the Swedish Energy Agency for supporting this study under the "Effsys EXPAND" research program.

References

Akasaka, R., Higashi, Y., Yamada, Y., Shibamura, T., 2015. Thermodynamic properties of 1,1,1,2-tetrafluoroethane (R-134a) + 2,3,3,3-tetrafluoropropene (R-1234yf) mixtures: Measurements of the critical parameters and a mixture model based on the multi-fluid approximation. *Int. J. Refrigeration* 58, 146-153.

Apra, C., Greco, A., Maiorino, A., 2013. The substitution of R134a with R744: An exergetic analysis based on experimental data. *Int. J. Refrigeration* 36(8), 2148-2159.

Calm, J.M., 2002. Emissions and environmental impacts from air-conditioning and refrigeration systems. *Int. J. Refrigeration* 25(3), 293-305.

Carpenter, N.E., 1992. Special Issue on R134a. Retrofitting HFC134a into existing CFC12 systems. *Int. J. Refrigeration*, 15(6), 332-339.

Joybari, M.M., Hatamipour, M.S., Rahimi, A., Modarres, F.G., 2013. Exergy analysis and optimization of R600a as a replacement of R134a in a domestic refrigerator system. *Int. J. Refrigeration* 36, 1233-1242.

Lemmon, E.W., Huber, M.L., McLinden, M.O., 2013. NIST Standard Reference Database 23: Reference Fluid Thermodynamic and Transport Properties-REFPROP, Version 9.1. National Institute of Standards and Technology, Standard Reference Data Program, Gaithersburg, MD, USA.

McLinden, M.O., Kazakov, A.F., Brown, J.S., Domanski, P.A., 2014. A thermodynamic analysis of refrigerants: Possibilities and tradeoffs for Low-GWP refrigerants. *Int. J. Refrigeration* 38, 80-92.

Mendoza-Miranda, J.M., Mota-Babiloni, A., Navarro-Esbrí, J., 2016. Evaluation of R448A and R450A as low-GWP alternatives for R404A and R134a using a micro-fin tube evaporator model. *Applied Thermal Engineering* 98, 330-339.

Mota-Babiloni, A., Navarro-Esbrí, J., Barragán, Á., Molés, F., Peris, B., 2015a. Analysis based on EU Regulation No 517/2014 of new HFC/HFO mixtures as alternatives of high GWP refrigerants in refrigeration and HVAC systems. *Int. J. Refrigeration* 52, 21-31.

Mota-Babiloni, A., Navarro-Esbrí, J., Barragán, Á., Molés, F., Peris, B., 2014. Drop-in energy performance evaluation of R1234yf and R1234ze(E) in a vapor compression system as R134a replacements. *Appl. Therm. Eng.* 71(1), 259-265.

Mota-Babiloni, A., Navarro-Esbrí, J., Barragán, Á., Molés, F., Peris, B., 2015c. Drop-in analysis of an internal heat exchanger in a vapour compression system using R1234ze(E) and R450A as alternatives for R134a. *Energy* 90(2), 1636-1644.

Mota-Babiloni, A., Navarro-Esbrí, J., Barragán-Cervera, Á., Molés, F., Peris, B., 2015b. Experimental study of an R1234ze(E)/R134a mixture (R450A) as R134a replacement. *Int. J. Refrigeration* 51, 52-58.

Myhre, G., Shindell, D., Bréon, F.-M., Collins, W., Fuglestvedt, J., Huang, J., Koch, D., Lamarque, J.-F., Lee, D., Mendoza, B., Nakajima, T., Robock, A., Stephens, G., Takemura, T., Zhang, H., 2013. Anthropogenic and Natural Radiative Forcing. In: *Climate Change 2013: The Physical Science Basis. Contribution of Working Group I to the Fifth Assessment Report of the Intergovernmental Panel on Climate Change*. Cambridge University Press, Cambridge, United Kingdom and New York, NY, USA.

Palm, B., 2008. Hydrocarbons as refrigerants in small heat pump and refrigeration systems - a review. *Int. J. Refrigeration* 31, 552-563.

Sedrez, P.C., Barbosa Jr., J.R., 2015. Relative permittivity of mixtures of R-134a and R-1234yf and a polyol ester lubricating oil. *Int. J. Refrigeration* 49, 141-150.

Sethi, A., Vera Becerra, E., Yana Motta, S., 2016. Low GWP R134a replacements for small refrigeration (plug-in) applications. *Int. J. Refrigeration* 66, 64-72.

Taylor, J.R., 1997. *An Introduction to Error Analysis*, second ed. University Science Books, Sausalito.

The European Parliament and the Council of the European Union, 2014. Regulation (EU) No 517/2014 of the European Parliament and the Council of 16 April 2014 on fluorinated greenhouse gases and repealing Regulation (EC) No 842/2006. *Official Journal of the European Union* 150, 195-230.

UN, 1997. *Kyoto Protocol to the United Nations framework convention on climate change*. New York, NY, USA.

Velders, G.J.M., Fahey, D.W., Daniel, J.S., Andersen, S.O., McFarland, M., 2015. Future atmospheric abundances and climate forcings from scenarios of global and regional hydrofluorocarbon (HFC) emissions. *Atmospheric Environment* 123, 200-209.

Accepted Manuscript

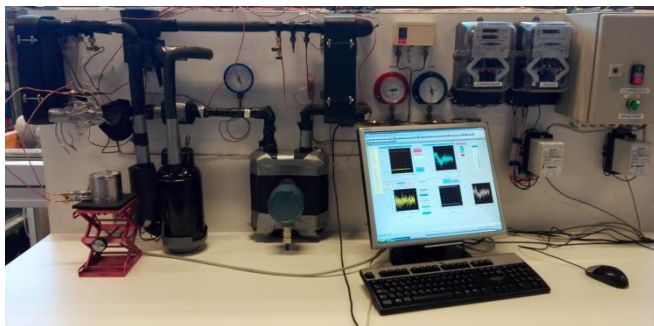

a)

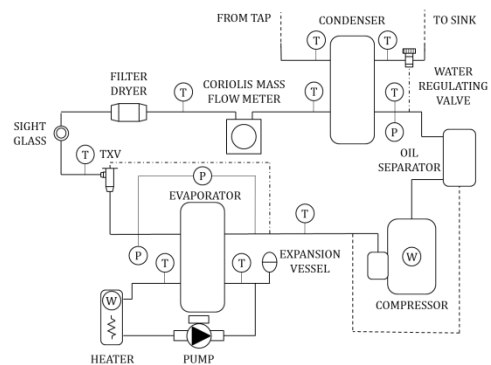

b)

Figure 1. a) Experimental test bench and b) schematic diagram

Accepted Manuscript

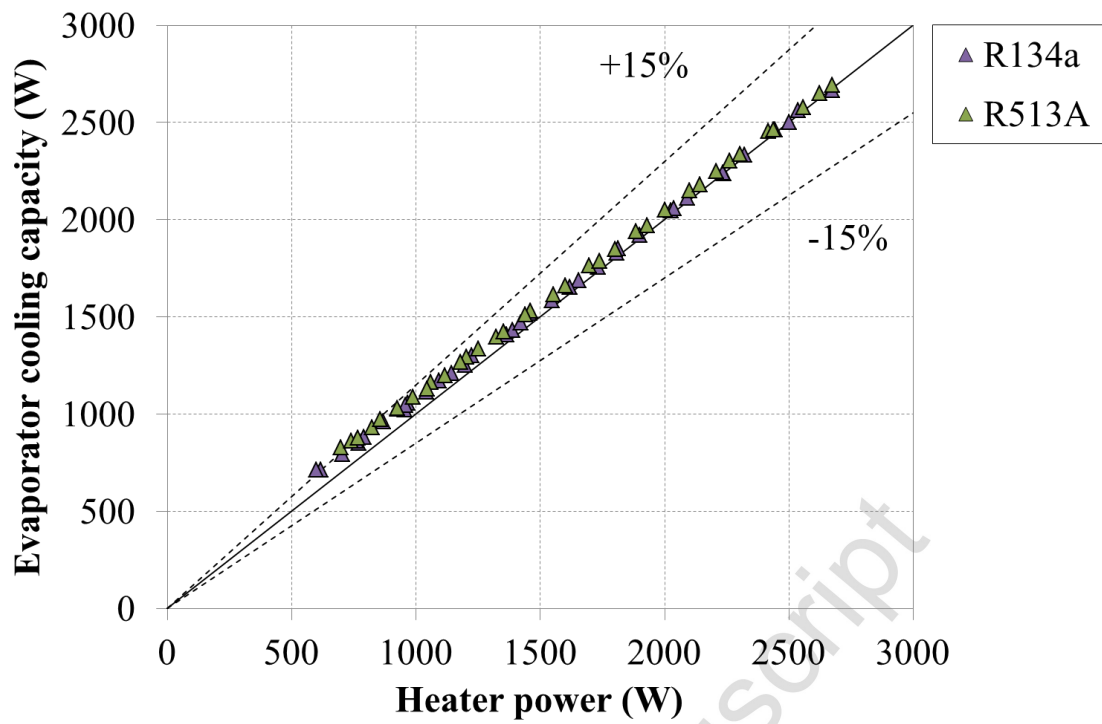

Figure 2. Evaporator heat balance

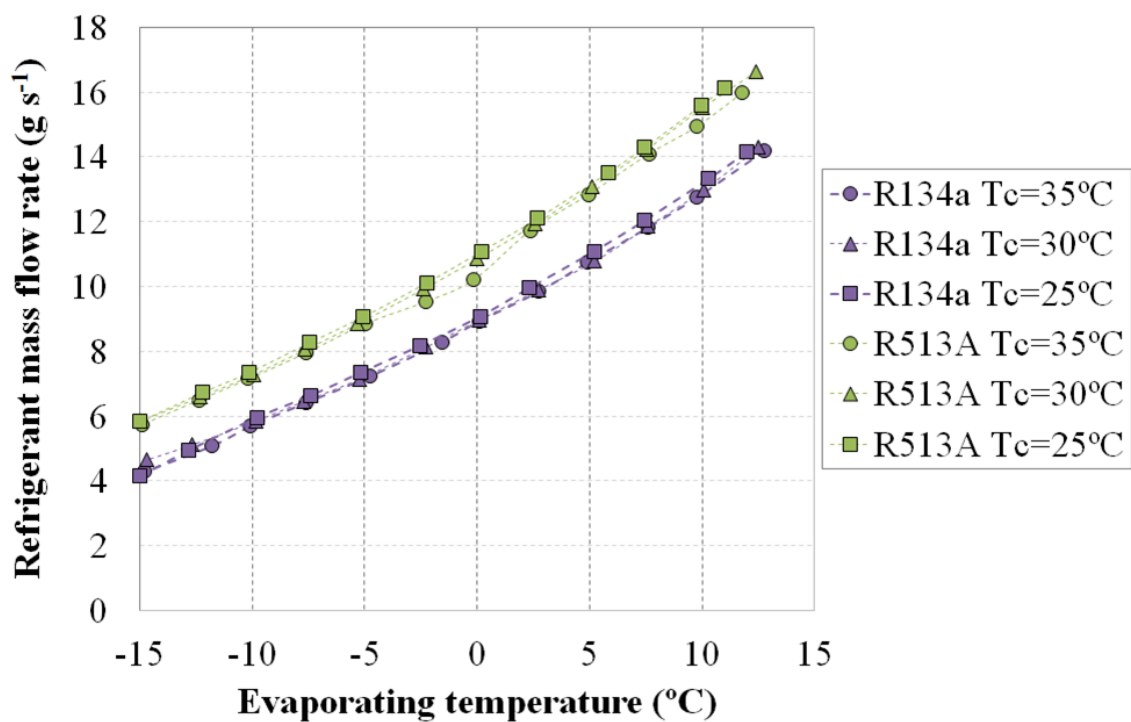

Figure 3. Experimental mass flow rate at different evaporating and condensing temperatures

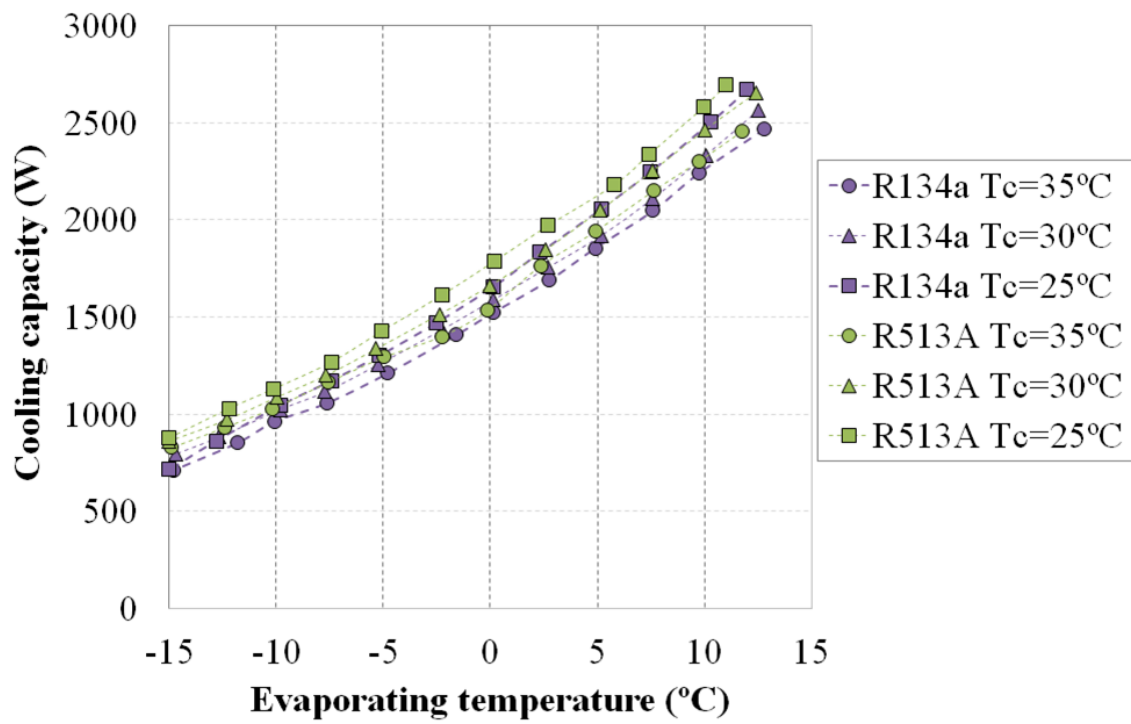

Figure 4. Cooling capacity at different evaporating and condensing temperatures

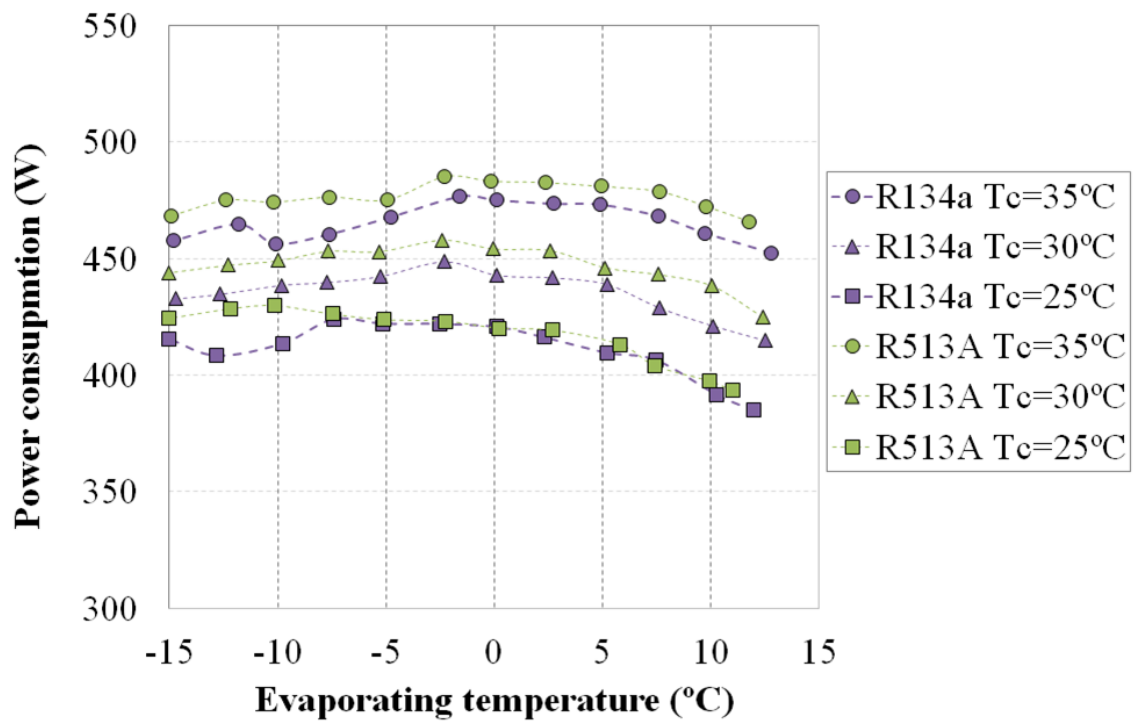

Figure 5. Power consumption at different evaporating and condensing temperatures

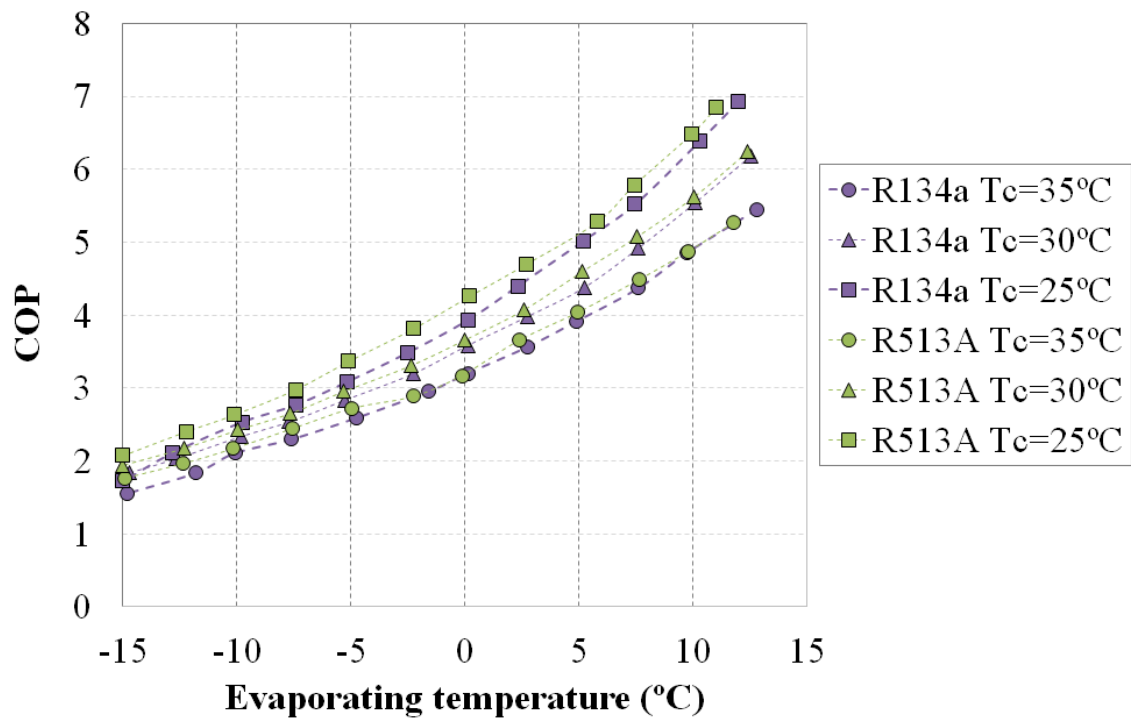

Figure 6. COP at different evaporating and condensing temperatures

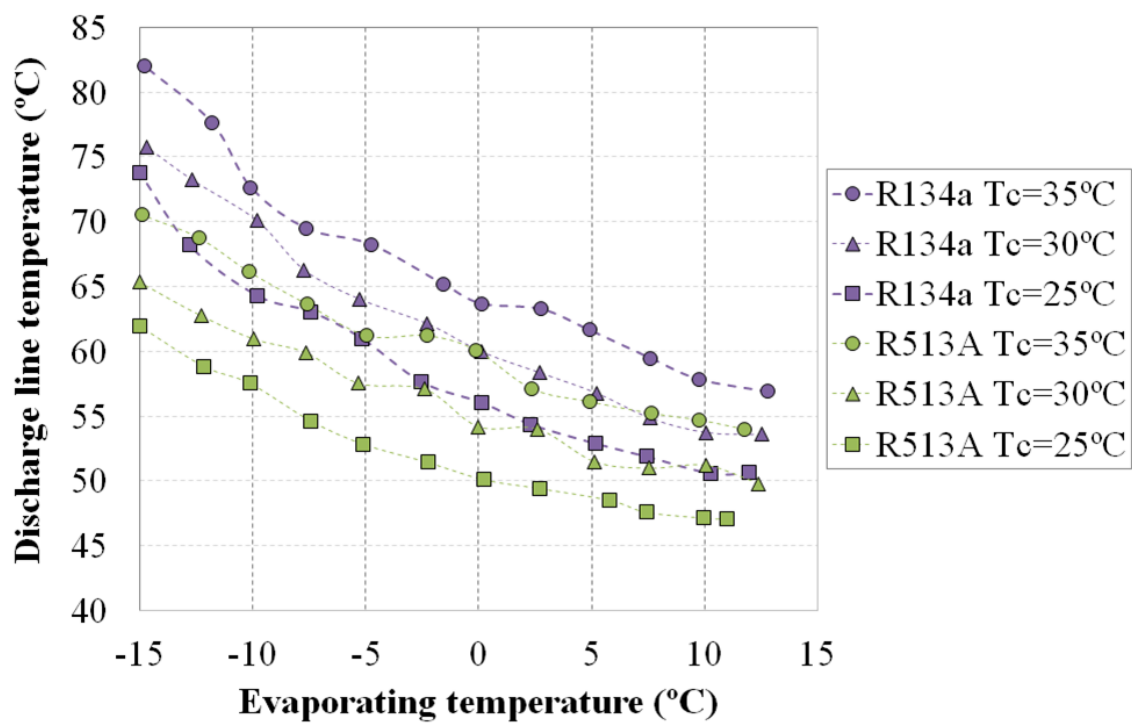

Figure 7. Discharge line temperatures at different evaporating and condensing temperatures

FIGURE CAPTIONS

Figure 1. a) Experimental test bench and b) schematic diagram

Figure 2. Evaporator heat balance

Figure 3. Experimental mass flow rate at different evaporating and condensing temperatures

Figure 4. Cooling capacity at different evaporating and condensing temperatures

Figure 5. Power consumption at different evaporating and condensing temperatures

Figure 6. COP at different evaporating and condensing temperatures

Figure 7. Discharge line temperatures at different evaporating and condensing temperatures

Accepted Manuscript

Table 1. Main characteristics of R134a and the commercial HFO/HFC mixtures

Refrigerant	R134a	R513A
Composition	pure	R134a/1234yf 44/56
ASHRAE safety classification	A1	A1
ODP	0	0
GWP _{100-yr} (AR5, Myhre et al., 2013)	1300	573
Critical temperature (°C)	101.1	97.7
Critical pressure (kPa)	4059.3	3855.3
NBP (°C)	-26.4	-29.9
Glide (°C) at 100kPa	0	0.1
Liquid density ^a (kg m ⁻³)	1295.3	1222.4
Vapor density ^a (kg m ⁻³)	14.35	17.14
Liquid c _p ^a (kJ kg ⁻¹ °C ⁻¹)	1.341	1.313
Vapor c _p ^a (kJ kg ⁻¹ °C ⁻¹)	0.897	0.920
Liquid thermal conductivity ^a (W m ⁻¹ °C ⁻¹)	92.08	79.26
Vapor thermal conductivity ^a (W m ⁻¹ °C ⁻¹)	11.50	11.72
Liquid viscosity ^a (Pa s ⁻¹)	267.0	227.5
Vapor viscosity ^a (Pa s ⁻¹)	10.7	10.5

^a At 0°C

Table 2. Theoretical overview of R513A and R134a performance.

	R134a	R513A
Refrigerating effect (kJ kg^{-1})	173.2	151.1
Vapor density at the compressor inlet (kg m^{-3})	11.5	13.8
Volumetric cooling capacity (kW)	1987	2081
COP (-)	5.49	5.44

Accepted Manuscript

Table 3. Tests operating conditions.

Operating conditions	Values
Evaporating temperatures (°C)	[-15,12.5] at steps of 2.5
Condensing temperatures (°C)	25, 30 and 35
Superheating degree (°C)	10.5 (at $T_c=35$ and $T_{evap}=0$)
Subcooling degree (°C)	7 (at $T_c=35$ and $T_{evap}=0$)
Refrigerant amount (g)	510 for R513A and 450 for R134a

Accepted Manuscript

Table 4. Minimum and maximum experimental velocities at the test bench lines

Velocity (m s^{-1}) at	R134a		R513A	
Suction line	11.31	14.97	12.73	15.00
Discharge line	1.53	6.10	1.71	5.94
Liquid line	0.04	0.15	0.06	0.18

Accepted Manuscript